

# Historic Design Standards

---

City of Austin  
September 2022

# Welcome

In Austin, historic preservation encourages the preservation of historic buildings, structures, sites, and districts; promotes awareness of cultural and architectural heritage; and helps shape a more sustainable, equitable, and livable place. As the city grows, these Historic Design Standards will help property owners, designers, builders, and historic preservation professionals make consistent decisions about how to meet present-day needs while stewarding local built heritage and achieving larger goals. Clear standards and graphics show good practices, as well as changes to avoid.

The Historic Design Standards were created by a working group representing property owners, designers, developers, advocates, and the Historic Landmark Commission. The working group sought to develop locally relevant standards grounded in national preservation principles. Many members are laypeople, and readability was a key concern: the standards needed to be understandable by property owners and neighbors considering whether to apply for historic district designation, as well as by architects. A Maintenance and Preservation chapter and illustrated glossary support those who want to learn more about architectural elements and materials.

The Historic Design Standards promote long-term sustainability by supporting the retention and repair of existing buildings, which keep tons of old-growth wood and other material in use and out of the landfill. They also support sustainable solutions for making buildings more energy efficient *now*, from high-impact improvements like attic insulation and duct sealing to DIY changes such as weather-stripping around windows and doors.

Historic Preservation Office staff are available to answer questions and provide feedback on proposed projects. Reach out to [preservation@austintexas.gov](mailto:preservation@austintexas.gov) or call (512) 974-3393.

# Acknowledgments

## *Design Standards Working Group*

The Historic Landmark Commission created the Design Standards Working Group on September 24, 2018 to create a new set of historic design standards, with the goals of providing clear, user-friendly standards and guidelines for all historic property owners and of simplifying the historic district application process. This document is the product of the working group's efforts and is modeled on the Preservation Austin design standards template produced through a community initiative in April 2011.

Janet Beinke  
Historic district property owner

Cara Bertron  
Historic Preservation Office staff

David Carroll, AIA  
Urban Design Commission, preservation architect

Madeline Clites  
Preservation consultant

Angela Gaudette  
Historic Preservation Office staff

Laura Keating  
Urban Design staff

David Keene  
Representative from potential historic district, National Register district property owner

Kevin Koch, AIA  
Historic Landmark Commission, preservation architect

Richard Kooris  
Landmark owner, developer, Preservation Austin board

Crystal LaCount  
Public History graduate student at Texas State

Karen McGraw, AIA  
Planning Commissioner (prev.), preservation architect

Terri Myers  
Historic Landmark Commission, preservation consultant

Tere O'Connell, AIA  
National Register district property owner, preservation architect

Marie Oehlerking-Read  
Texas Historical Commission staff (prev.)

Misael Ramos  
Representative from potential historic district

Angela Reed  
Landmark owner, property owner in potential historic district, Texas Historical Commission staff

Emily Reed  
Historic Landmark Commission, preservation consultant

Paula Rhodes  
Historic district property owner, preservation architect

Kate Singleton  
Preservation Austin staff (prev.)

Blake Smith  
Builder, Preservation Austin board

Amy Thompson  
Landmark owner

Beth Valenzuela  
Historic Landmark Commission, preservation consultant

Lorre Weidlich  
Historic district and National Register district property owner

Caroline Wright  
Texas Historical Commission staff, Preservation Austin board

Thanks also to David Carroll, Jim Nix, John Rosato, Michele Van Hyfte, and Caroline Wright for participating in a commercial/downtown focus group.

## *Graduate Program in Historic Preservation, UT Austin*

In fall 2018, the Preservation Planning and Practice class at UT Austin completed a comparative case study analysis of historic design standards across twelve U.S. cities. Thanks to Michael Holleran and his students for

the helpful groundwork: Estefanía Barreto, Rosa Fry, Sofia Gonzalez, Junyeoung Jeon, Lauren Kelly, Karen Kincaid Brady, Meghan King, Tolu Oliyide, Hanbaek Park, Rachel Rettaliata, Taylor Roche, and Vangie Ulila.

# Contents

---

<b>Introduction</b>	<b>1</b>
Who Should Use These Standards	3
When the Standards Apply	3
Design Standards and Other Regulations	5
Character-Defining Features	5
Preservation Principles	7
Contributing and Noncontributing Properties	9
Incentives for Rehabilitation	9
<b>When to Use the Design Standards</b>	<b>11</b>
What Projects Require Historic Review	13
How the Historic Review Process Works	15
Administrative and Commission Review	17
Exceptions	20
Appeals and Penalties	20
Responsibilities of the Applicant	20
<b>Modern Codes and Energy Efficiency</b>	<b>21</b>
<b>Repair and Alterations</b>	<b>27</b>
General Standards	29
Foundations	31

---

Roofs	33
Exterior Walls and Trim	35
Windows, Doors, and Screens	37
Porches	41
Chimneys	43
Light Fixtures	43
Accessory Buildings	43
Commercial Storefronts	45
<b>Residential Additions</b>	<b>47</b>
<b>Residential New Construction</b>	<b>57</b>
<b>Commercial Additions</b>	<b>69</b>
<b>Commercial New Construction</b>	<b>77</b>
<b>Institutional Buildings</b>	<b>83</b>
<b>Sites and Streetscapes</b>	<b>87</b>
<b>Demolition and Relocation</b>	<b>95</b>
<b>Maintenance and Preservation of Historic</b>	
<b>Materials</b>	<b>99</b>
<b>Glossary</b>	<b>105</b>
<b>Image Credits</b>	<b>125</b>

# Introduction



Who should use these standards 3

When the standards apply 3

Design standards and other regulations 5

Character-defining features 5

Preservation principles 7

Contributing and noncontributing properties 9

Incentives for rehabilitation 9

---

Historic buildings and neighborhoods contribute to Austin’s livability, economy, and identity. These design standards support property owners who are reinvesting in their historic buildings through maintenance, repair, rehabilitation, and restoration. They also provide guidance for new construction and additions to ensure changes are compatible with existing character.

The design standards aim to accomplish the following goals:

- Provide easy-to-use standards for property owners and design professionals to plan projects
- Provide clear direction for stewardship of historic properties and historic districts
- Ensure that additions and new construction are compatible with historic buildings
- Provide guidance for increasing energy efficiency of historic buildings
- Increase predictability in the historic review process

The design standards do not prevent change. Rather, they seek to help historic buildings and neighborhoods evolve while contributing to the long-term sustainability of those neighborhoods and the city as a whole.

The design standards support the goals of the Imagine Austin Comprehensive Plan and Strategic Direction 2023 to protect historic resources, ensure that new development is compatible with historic character, and reflect Austin’s diverse history in the places that are preserved.

## Who Should Use these Standards

The Historic Design Standards are a tool for property owners, contractors, design professionals, and anyone else planning a project that will:

- Alter the exterior or site of a historic building
- Construct an addition to a historic building
- Construct a stand-alone new building on a historic landmark property or in a historic district

The standards also are an important resource for the Historic Landmark Commission and City staff in evaluating projects. They ensure that the people who

plan a project and the people who review it are using the same clear standards.

Residents of a historic district can create a district-specific supplement to the Historic Design Standards with more specific or restrictive standards relating to—for example—building height, porch depth, construction materials, or permanent landscape elements. A supplement may not contradict the requirements of these design standards and should be based on the features and characteristics of the historic district.

## When the Standards Apply

Three types of historic properties are regulated through the City of Austin historic review process.

	<i>What are they?</i>	<i>Who designates them?</i>	<i>Do they need to follow these design standards?</i>
Historic landmarks	Individually significant buildings	City Council	✓
Historic districts (locally designated)	Intact older neighborhoods containing contributing (historic) and noncontributing properties.	City Council	✓ If designated after January 2021, or if the district has adopted the design standards*
National Register districts	Intact older neighborhoods containing contributing (historic) and noncontributing properties.	National Park Service	~ Recommended, not required

Recorded Texas Historic Landmarks, State Antiquities Landmarks, National Historic Landmarks, and properties individually listed in the National Register of Historic Places are not subject to the City’s historic review process. Contact the Texas Historical Commission at 512-463-6094 or [architecture@thc.texas.gov](mailto:architecture@thc.texas.gov) for more information on these designations.

\* Historic districts designated before January 2021 are regulated by the design standards approved at the time of designation. These districts may adopt the Historic Design Standards to replace the previous standards if desired.



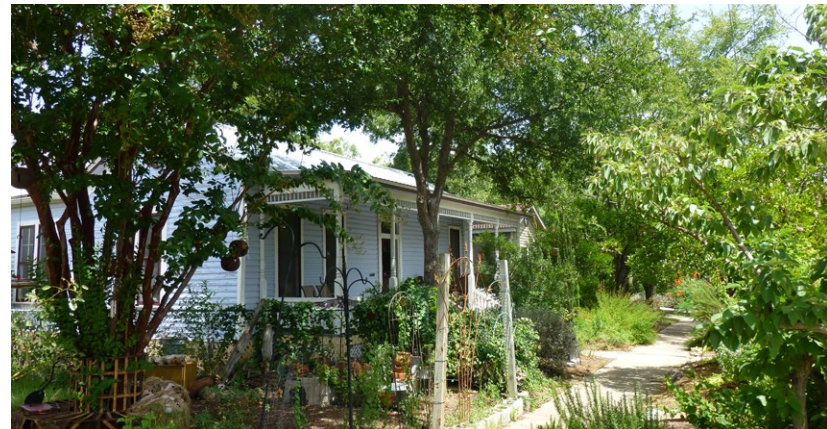

Historic review projects showcase Austin's rich and diverse architecture and include signage, small projects, major rehabilitations, additions, and new buildings.

**Resources:**

- [Land Development Code](#)
- [Historic Preservation Office](#)
- [Historic Landmark Commission](#)

## Design Standards and Other Regulations

The design standards can modify Land Development Code regulations for building setbacks and height, compatibility, permanent landscape elements, parking, and signs. In case of a conflict with the Land Development Code, including the East Sixth/Pecan Street and Congress Avenue overlay districts, the design standards shall control. This does not apply to National Register districts, where the design standards are advisory.

The design standards take priority over City of Austin code requirements for minimum R-values. See the **Modern Codes and Energy Efficiency** chapter for additional information on code compliance and energy efficiency.

The City of Austin does not enforce private deed restrictions, covenants, or easements.

## Character-Defining Features

Character-defining features are the architectural and site features that make a property or district special. These physical elements help convey the story of how a place developed. The design standards ensure that character-defining features are retained as properties and districts are repaired, rehabilitated, and expanded. For historic districts, the standards prioritize the retention of character-defining features as seen from the public realm (the street). For historic landmarks,

character-defining features must be retained for the entire building exterior and site.

Historic district applications describe character-defining features in detail and should be used as close companions to the design standards. It is strongly recommended that owners of historic landmarks work with City staff to determine character-defining features of their properties early in project planning.

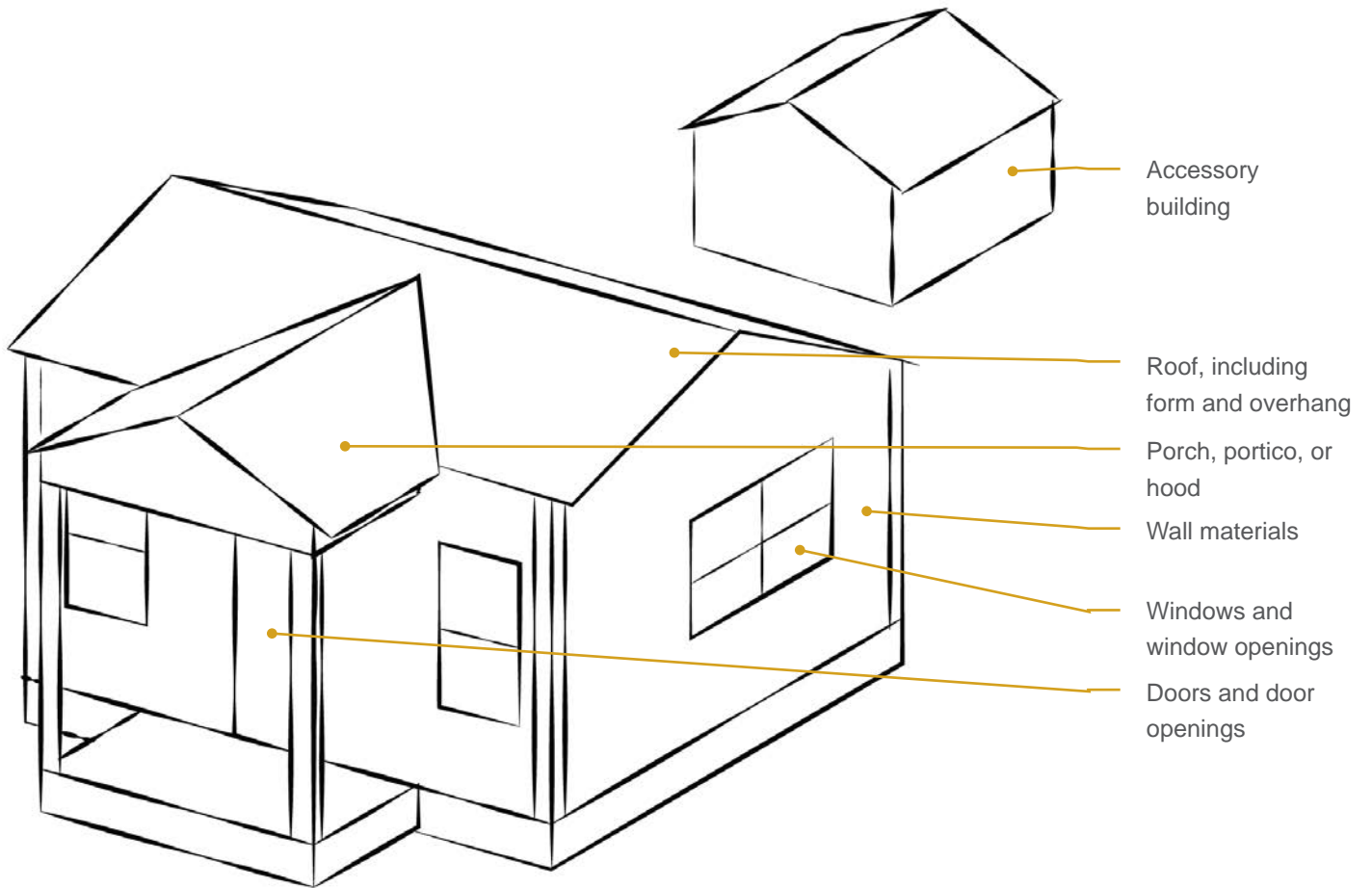

Character-defining features include all parts of a property, from a building's siding and windows to distinctive ornamentation, secondary structures, and permanent site features.

In a historic district, character-defining features may include parts of the public realm.

Resources:

- [Architectural Character—Identifying the Visual Aspects of Historic Buildings as an Aid to Preserving their Character](#) (Preservation Brief 17) by the National Park Service

## Preservation Principles

The Secretary's Standards for the Treatment of Historic Properties are professional standards developed by the National Park Service. The Standards guide historic preservation practice throughout the United States and include four treatments, or approaches, to historic properties: preservation, rehabilitation, restoration, and reconstruction. Rehabilitation, the most common approach, provides flexibility to address modern needs while maintaining historic character-defining features.

These design standards are based on the Secretary of the Interior's Standards for Rehabilitation, called "Secretary's Standards" in this document. If any aspect of a proposed project is not covered by the design standards, the Secretary's Standards shall be used. In certain circumstances, use of the other treatments may be proposed.

### *Secretary's Standards for Rehabilitation*

1. A property shall be used for its historic purpose or be placed in a new use that requires minimal change to the defining characteristics of the building and its site and environment.
2. The historic character of a property shall be retained and preserved. The removal of historic materials or alteration of features and spaces that characterize a property shall be avoided.
3. Each property shall be recognized as a physical record of its time, place, and use. Changes that create a false sense of historical development, such as adding conjectural features or architectural elements from other historic buildings, shall not be undertaken.
4. Most properties change over time; those changes that have acquired historic significance in their own right shall be retained and preserved.
5. Distinctive features, finishes, and construction techniques or examples of craftsmanship that characterize a property shall be preserved.
6. Deteriorated historic features shall be repaired rather than replaced. Where the severity of deterioration requires replacement of a distinctive feature, the new feature shall match the old in design, color, texture, and other visual qualities and, where possible, materials. Replacement of missing features shall be substantiated by documentary, physical, or pictorial evidence.
7. Chemical or physical treatments, such as sandblasting, that cause damage to historic materials shall not be used. The surface cleaning of structures, if appropriate, shall be undertaken using the gentlest means possible.
8. Significant archaeological resources affected by a project shall be protected and preserved. If such resources must be disturbed, mitigation measures shall be undertaken.
9. New additions, exterior alterations, or related new construction shall not destroy historic materials that characterize the property. The new work shall be differentiated from the old and shall be compatible with the massing, size, scale, and architectural features to protect the historic integrity of the property and its environment.
10. New additions and adjacent or related new construction shall be undertaken in such a manner that if removed in the future, the essential form and integrity of the historic property and its environment would be unimpaired.



The Secretary's Standards emphasize repair of historic building materials over replacement.

---



The Secretary's Standards recommend retaining historic-age changes as part of the building's story.

---



**Resources:**

- [Secretary's Standards and Guidelines for Preserving, Rehabilitating, Restoring & Reconstructing Historic Buildings](#)

## Contributing and Noncontributing Properties

Locally designated historic districts and National Register districts include two types of properties: contributing and noncontributing. This classification is assigned when the district is designated. Contributing properties were built during the district’s period of significance—typically, when most construction happened—and retain sufficient integrity to convey their history. This means that they have not been altered in ways that obscure or remove the character-defining features linking them to the past. These design standards typically refer to contributing properties as “historic.”

Noncontributing properties were either constructed outside the period of significance of the district or have been altered too much to convey an accurate sense of history. A property owner can choose to return a historic-age noncontributing property to contributing status through careful rehabilitation or restoration.

The design standards apply to contributing and noncontributing properties depending on the project type.

<i>Does a project need to follow these design standards?</i>	
Alterations	✓ Contributing properties
	~ Noncontributing properties—recommended, not required
Additions	✓ Contributing properties
	~ Noncontributing properties—recommended, not required
Stand-alone new construction	✓ Contributing properties
	✓ Noncontributing properties
Site work (permanent)	✓ Contributing properties
	~ Noncontributing properties—recommended, not required

## Incentives for Rehabilitation

Two types of rehabilitation incentives are available in Austin, depending on where your property is located. Each has a minimum threshold for expenditures. Historic landmarks may also receive an annual partial tax exemption.

### *Locally designated historic districts*

- Local rehabilitation incentive freezes the City’s portion of property taxes for 7 to 10 years
- Available to homestead and income-producing properties
- Contributing properties and properties being restored to contributing status both qualify
- Contact the [Historic Preservation Office](#) for more information

### *National Register districts*

- State and federal historic tax credits can contribute up to 45 percent of eligible costs
- Available to income-producing properties (federal and state) and nonprofits (state)
- Contributing properties qualify
- Contact the [Texas Historical Commission](#) and [National Park Service](#) for more information



CONTRIBUTING. This building retains its design, form, materials, and craftsmanship in ornamentation.

---



CONTRIBUTING. This building has a rear addition but retains its design, form, materials, and craftsmanship.

---



NONCONTRIBUTING. This building was constructed during the district's period of significance, but a prominent addition substantially alters its design and form.

---



NONCONTRIBUTING. This building was constructed outside of the district's period of significance.

---



# When to Use the Design Standards

---

*What projects require historic review 13*

*In-kind repair 13*

*How the historic review process works 15*

*Administrative and Commission review 17*

*Exceptions 20*

*Appeals and penalties 20*

*Responsibilities of the applicant 20*



---

When a property owner or tenant initiates a construction project that will alter the exterior appearance of a historic property and/or remove historic exterior material, the historic review process—and the design standards—must be followed. The design standards do not require people to make changes to their historic properties or restore buildings to their original appearance.

Though routine maintenance and repair projects do not require formal historic review and approval, regular maintenance is an important part of owning a historic property. See the **Repair and Alterations** chapter for guidance.

If a historic property is also designated a [Recorded Texas Historic Landmark](#) or a [State Antiquities Landmark](#), additional review by the Texas Historical Commission will be required. The applicant is responsible for submitting the proposed work to the Texas Historical Commission for review.

For more information, visit the [Historic Preservation Office website](#) or contact staff at [preservation@austintexas.gov](mailto:preservation@austintexas.gov).

## What Projects Require Historic Review

Historic review and approval are required for exterior or site changes to all historic landmarks and contributing buildings in a historic district; the design standards refer to both of these property types as “historic properties.” Historic review and approval are also required for stand-alone new construction on properties that include a historic landmark and on any property in a historic district.

In historic districts, proposed changes are typically evaluated for their impacts that are visible from public rights-of-way. Proposed changes to historic landmarks will be scrutinized for their impacts on all aspects of the property.

Properties in National Register districts also must go through the historic review process, but the resulting comments are advisory recommendations, not requirements.

*Historic review is required to:*

- Replace elements on the exterior of a historic building, including but not limited to siding, porches, doors, windows, or roof materials (except in-kind replacement of roof materials)
- Alter permanent site features of a historic property, including but not limited to decks, pools, walls, fences, and bridges
- Construct an addition to a historic building
- Construct a stand-alone new building
- Relocate a building to a historic district or a historic landmark property
- Demolish or relocate a historic building or parts of a historic building
- Install a commercial awning or a sign
- Clean, repaint, or paint a masonry building
- Paint a historic landmark a different color

*Historic review is not required to:*

- Remodel the interior of a historic building
- Complete routine maintenance and repair projects such as replacing roof material with the same material, patching siding with the same material, repairing the foundation, and painting (except for historic landmarks)
- Alter or add to noncontributing buildings



*Note on historic landmarks*

Historic landmarks are individually significant properties designated by the City of Austin. They represent important local stories: of community and business leaders, Civil Rights activists, innovative architects, and others who shaped the culture of Austin. Because of the significance of historic landmarks, the Historic Landmark Commission may limit alterations and additions.

---

## In-Kind Repair

One of the advantages of historic buildings is that repairs can be completed over time, rather than the expensive all-at-once effort of constructing a new building. In-kind repairs use the same material, with the same design and profile, to repair or replace a small area of deteriorated or damaged historic materials. For example, in-kind siding replacement might use wood siding with the same profile to replace a small area of deteriorated siding. Write [preservation@austintexas.gov](mailto:preservation@austintexas.gov) to ask if a project can be considered in-kind repair or will require historic review.



The historic review process ensures that projects meet agreed-on standards for stewardship of built heritage.



#### Resources:

- [Land Development Code](#)
- [Historic Preservation Office](#)

## How the Historic Review Process Works

Historic review must be completed to receive a building, demolition, or relocation permit. If another City permit is required, applicants can initiate the historic review process before or at the same time as the permit application submission. Applicants are encouraged to begin the historic review process early in the design development process.

When planning a project, closely review the relevant design standards, then contact the Historic Preservation Office to determine if historic review is required and if review by the Architectural Review Committee may be helpful. Next, submit a [historic review application](#) to [preservation@austintexas.gov](mailto:preservation@austintexas.gov).

The Historic Preservation Office may administratively approve minor changes to historic properties. All other projects are referred to the Historic Landmark Commission for review. Staff and Commission members use these design standards, any historic district supplements, design standards for districts created prior to January 2021, and the Secretary's Standards for Rehabilitation to guide decisions.

If an approved project requires changes for any reason, contact the Historic Preservation Office immediately. Another review may be required if the changes substantially modify the approved project.

Monthly Architectural Review Committee meetings offer the opportunity to receive feedback in advance of the full Historic Landmark Commission meeting. The meeting is optional, but many find the committee's feedback helpful in refining their proposals and streamlining the historic review process.

Applicants are strongly encouraged to consult with the local neighborhood association or historic district design review committee before and during the historic review process. Neighborhood groups can review the project against the design standards and provide advisory comments to the Historic Preservation Office and Historic Landmark Commission.

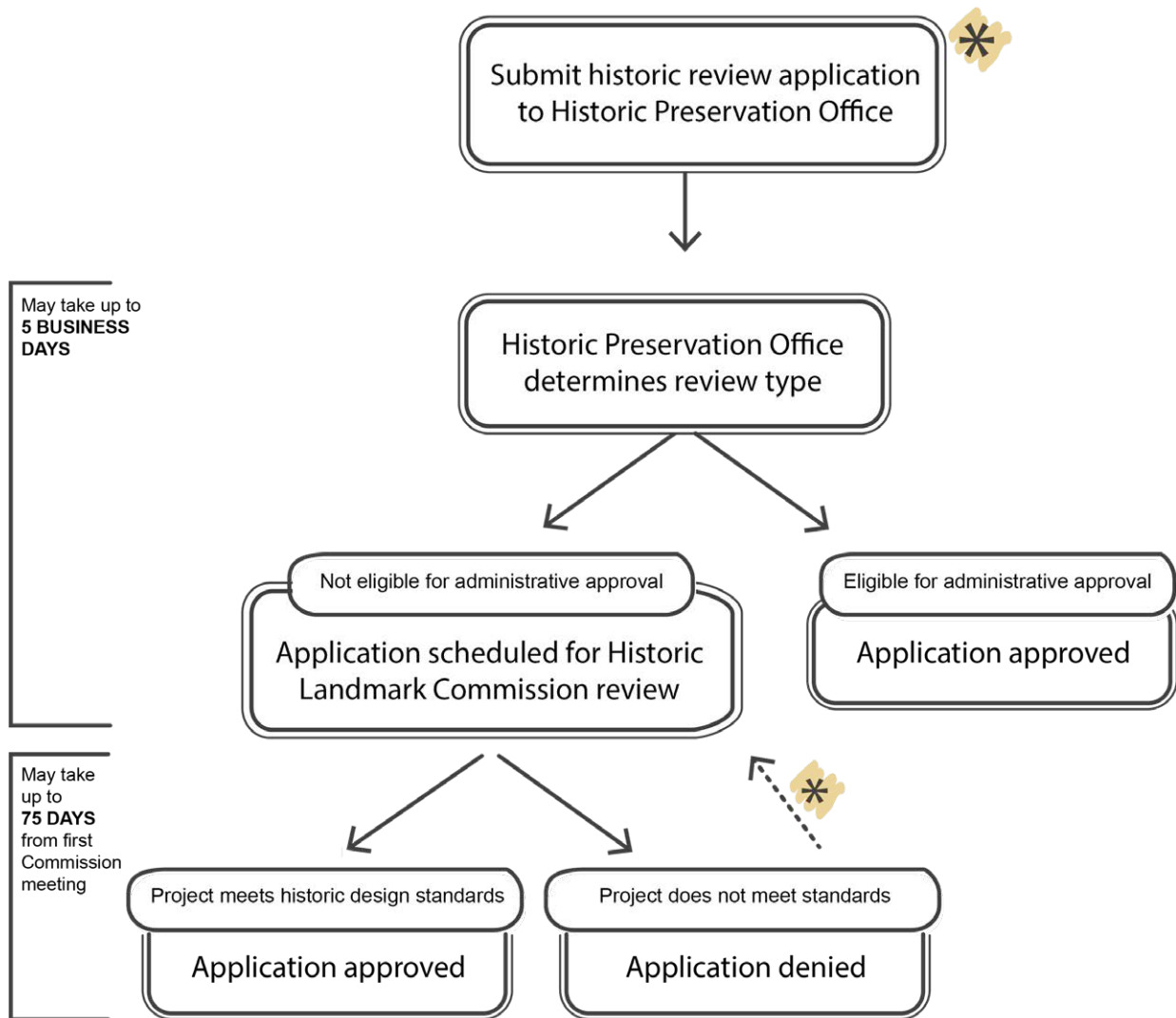

\* The Architectural Review Committee meets monthly to provide detailed feedback on proposed projects. You are not required to attend, but many people find the committee's feedback helpful. You can attend before or after formally submitting an application, and there is no associated fee.

## Administrative and Commission Review

Historic Preservation Office staff may administratively approve projects if they meet the relevant standards and do not impact the property's historic character from the street (historic district) or overall (historic landmark). If a project does impact the property's historic character, it must be reviewed by the Historic Landmark Commission.

If a noncontributing property proposed for demolition or relocation appears to meet the criteria for designation as a historic landmark, staff will refer it to the Historic Landmark Commission. This process is true for any 45+ year-old building in the city.

This chart is intended to provide general guidance; staff may refer any project for Commission review.

<i>Proposed work</i>	<i>Applicable chapter in design standards</i>	<i>Administrative review</i>	<i>Commission review</i>
<b>Alterations</b>			
Restore or reconstruct a documented missing historic architectural element	Repair and Alterations	x	
Replace a window on a secondary (non-front) wall that is not substantially visible from the street	Repair and Alterations	x	
Replace a window on the front wall	Repair and Alterations		x
Change window openings on secondary walls that are not substantially visible from the street (historic district only)	Repair and Alterations	x	
Change window openings on front walls	Repair and Alterations		x
Change front door opening	Repair and Alterations		x
Change door openings on secondary walls that are not substantially visible from the street (historic district only)	Repair and Alterations	x	
Add window screens or a screen door	Repair and Alterations	x	
Repoint a masonry building	Repair and Alterations	x	
Replace roofing with a different material	Repair and Alterations		x
Paint a historic landmark a different color	Repair and Alterations	x	
Install solar panels on a rear- or side-facing roof plane	Sites and Streetscapes	x	
Install solar panels on a front-facing roof plane	Sites and Streetscapes	x	
Install a rainwater catchment system	Sites and Streetscapes	x	

Proposed work	Applicable chapter in design standards	Administrative review	Commission review
<b>Additions</b>			
Construct a minimally visible one-story addition with an area less than 600 square feet	Residential Additions or Commercial Additions	x	
Construct a minimally visible two-story rear addition to a two-story building	Residential Additions or Commercial Additions	x	
Construct an addition that raises the height of the historic building (e.g., a third-story addition to a two-story building)	Residential Additions or Commercial Additions		x
Construct a highly visible addition or an addition with an area greater than 600 square feet	Residential Additions or Commercial Additions		x
<b>Stand-Alone New Construction</b>			
Construct a new house-scaled residential building	Residential New Construction		x
Construct an accessory building that is more than one story or 600 square feet	Residential New Construction		x
Construct a one-story accessory building with an area less than 600 square feet	Residential New Construction	x	
Construct a new commercial building	Commercial New Construction		x
<b>Site Work and Signage</b>			
Construct a ramp for accessibility (reversible work constructed of wood or other easily removable material)	Sites and Streetscapes	x	
Construct a ramp for accessibility (non-reversible work constructed of concrete or other non-removable material)	Sites and Streetscapes		x
Construct a pool	Sites and Streetscapes	x	
Construct a rear or side deck	Residential Additions	x	
Construct a front porch or deck	Residential Additions		x
Construct or alter a fence or site wall	Sites and Streetscapes	x	
Construct a new sidewalk	Sites and Streetscapes	x	
Install or alter a sign	Historic Sign Standards (separate document)	x	

## Administrative and Commission Review (con't)

<i>Proposed work</i>	<i>Applicable chapter in design standards</i>	<i>Administrative review</i>	<i>Commission review</i>
<b>Demolition and Relocation</b>			
Demolish or relocate a historic building	Demolition and Relocation		x
Demolish or relocate an accessory building in a historic district or National Register district	Demolition and Relocation	x	
Demolish or relocate an accessory building on a historic landmark property	Demolition and Relocation		x



## Exceptions

The Historic Landmark Commission may grant exceptions to the design standards if it determines that the proposed project will maintain the character-defining features of the historic property or district.

## Appeals and Penalties

Appeal of a historic review denial may be made to the land use commission and, if denied, to the City Council, following the process set forth in City code. The party filing the appeal must establish that the Historic Landmark Commission's decision is contrary to applicable law or regulation. Comments on projects in National Register districts are advisory and may not be appealed.

Any person or corporation who violates provisions of the design standards for a historic landmark or historic district is subject to the same criminal misdemeanor and civil penalties that apply to any other violation of City code. This does not apply in National Register districts.

## Responsibilities of the Applicant

These standards provide general guidance and standards. Professional guidance from an architect or experienced contractor may be necessary to address a building's unique materials and conditions. Historic Preservation Office staff and Historic Landmark Commission's Architectural Review Committee are also available to provide technical assistance.

The applicant is responsible for demonstrating that the proposed project meets these design standards. The Historic Preservation Office or Historic Landmark Commission may require additional documentation as necessary.

# Modern Codes and Energy Efficiency

---

*Modern building codes 23*

*Energy efficiency 23*

*Common concerns 25*

---

A goal of these standards is to help property owners to steward our built heritage, including retaining as much historic material as possible. Three situations typically drive requests to replace historic materials: meeting modern code, improving energy efficiency, and repairing damage. This chapter addresses the first two topics. The **Repair and Alterations** chapter deals with repair and replacement of damaged or deteriorated materials.

In the following sections, this symbol  is used to indicate a standard that achieves environmental sustainability goals—whether it is saving historic material from the landfill, improving energy efficiency, or another goal.

## Modern Building Codes

When rehabilitating or adding to a historic building, the existing building is subject to code review, sometimes requiring alterations to meet current code. As a general rule, the following statements apply when the design standards conflict with modern code:

- The City will not require replacement of historic windows or exterior wall materials to meet R-value or egress requirements.
- When replacing a roof, the City may require the replacement material to achieve R-value requirements, but it will not require the alteration of the roof form, pitch, or architectural details.
- When constructing a new commercial building, the City will allow clear glass on the first floor but may require an overhang or awning.

- Historic buildings must comply with accessibility requirements. See the **Sites and Streetscapes** chapter for applicable standards.

These design standards overrule code requirements for locally designated historic properties, with the exception of accessibility and life safety issues such as emergency egress. The design standards do not overrule code requirements in National Register districts, where they are advisory.

See the **Design Standards and Other Regulations** section in the Introduction to learn about how the standards relate to other regulations.

## Energy Efficiency

The City of Austin encourages energy efficiency for homes and businesses. Historic buildings naturally support energy efficiency and sustainability in many ways:

- Historic materials, particularly old-growth wood, are generally of higher quality and have longer life spans than modern materials. A historic wood-sash window can be maintained and repaired over and over again, while even the highest-quality modern windows may only last 20 to 30 years before failing.
- Retaining historic material saves embodied energy and keeps unnecessary waste out of landfills. Replacing materials to improve energy efficiency can ultimately “cost” more energy than retaining the existing materials. It can also cost more money: the payout period for a new window, for example, is 15 to 20 years.

Many energy efficiency changes can be made to historic buildings without removing or replacing historic exterior material, including:

### *Roofs and attics*

- Insulate the attic.
- Apply a radiant barrier to the underside of the roof.
- Ensure the attic has sufficient ventilation to allow trapped heat to escape.
- Install airtight insulated covers for pull-down attic stairs.

### *Exterior walls*

- Seal gaps and cracks in the structural envelope from the interior.
- Keep exterior joints caulked.
- Adding wall insulation risks trapping moisture inside the walls and is not recommended.

### *HVAC systems*

- Insulate and seal HVAC ducts to prevent leakage.



**Above:** Ramps and chair lifts can provide access while preserving historic character.



**Below:** The biggest sources of energy loss in buildings can be addressed without replacing historic fabric such as windows.

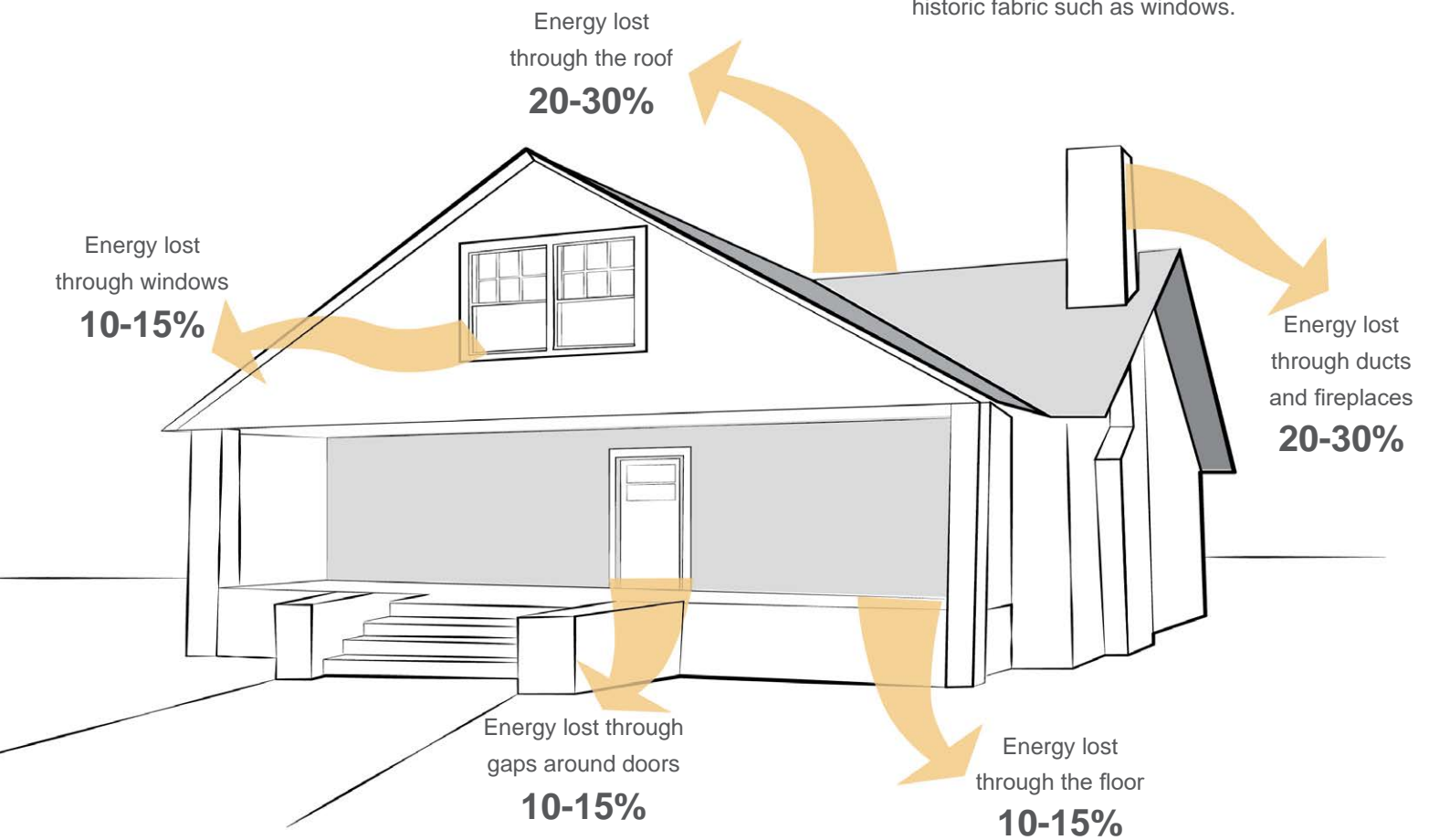

**Resources:**

- [Secretary of the Interior's Standards for Rehabilitation & Illustrated Guidelines on Sustainability for Rehabilitating Historic Buildings](#) by the National Park Service
- [Improving Energy Efficiency in Historic Buildings](#) (Preservation Brief 3) by the National Park Service

## Energy Efficiency (con't)

### *HVAC systems (con't)*

- Install high-efficiency central heating, ventilation, and air conditioning systems with modern controls.
- Install ceiling fans to increase comfort.

### *Windows*

- Install weather-stripping around existing windows and doors to prevent air and moisture infiltration.
- Add UV- and radiant energy-blocking film to existing windows; when appropriate, retrofit windows with insulated, low-emissivity (low-E) glass. Select window film or glass that does not have a noticeable tint, coloration, or reflectivity.
- Add solar screens to historic window screen frames, especially on side walls.
- Add removable interior window inserts to attain the efficiency and soundproofing qualities of

double-paned windows without impacting the historic windows.

- Plant trees where foliage will shade windows.
- Consider custom double-paned windows that reuse the existing historic frames.

Making these strategic changes will significantly improve a building's energy efficiency with a faster payback than window replacement. If other high-impact energy efficiency upgrades have been completed or are included in the same project, historic windows on non-street-facing walls may be replaced for energy efficiency.

### ★ *Note on historic landmarks*

Prioritize improvements that do not impact the exterior of the building.

---

## Common Concerns

*Concern: Historic buildings require more maintenance than new buildings.*

While historic buildings do present unique maintenance issues, every building requires maintenance. All property owners know (or quickly realize) that regular maintenance is necessary to protect their asset. Some older buildings are purchased in a state of deterioration because a previous owner was unable or unwilling to maintain the property. However, once issues are properly addressed, and with periodic upkeep, a historic building presents no more issues than a new building year after year.

*Concern: Older buildings are more expensive to update.*

Older buildings might have mechanical, electrical, or plumbing systems old enough to require replacement, but every building will need such work over time. Replacement of systems as required is preferable to the complete demolition of an existing building to replace it with a new one, from both historic preservation and sustainability perspectives.

*Concern: Older buildings are unsafe because of lead paint and asbestos.*

Professional removal or encapsulation of hazardous materials is required for either rehabilitation or demolition to address economic and health concerns. Such concerns should not encourage demolition of a historic building.

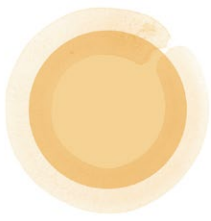

Solar panels can be compatible with historic roof forms.

---

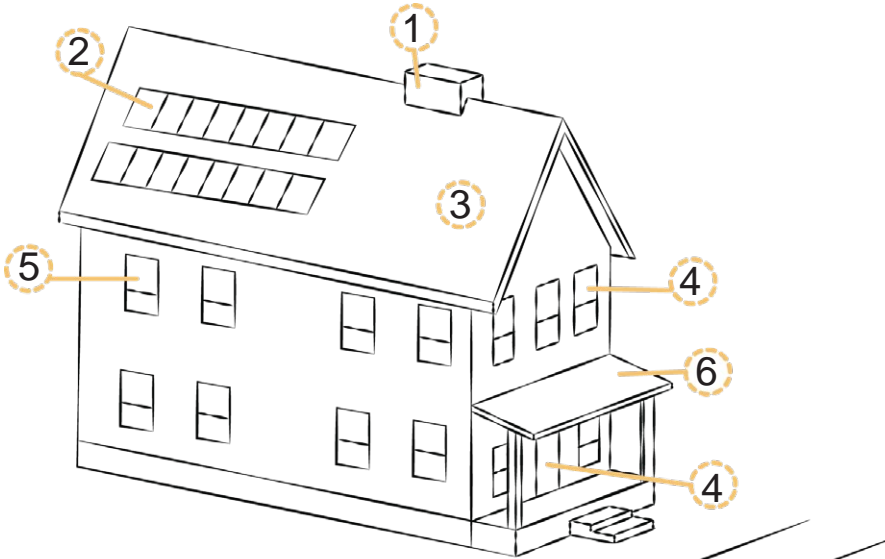
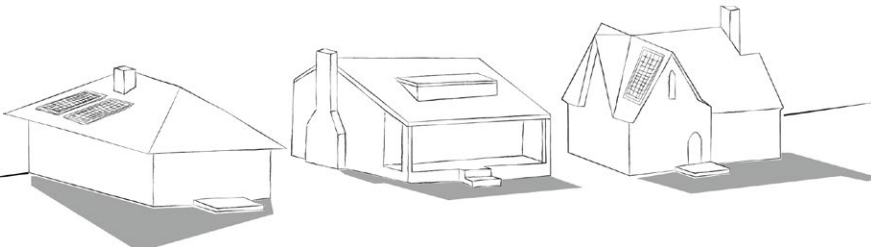

**For historic homes:**

- 1 Install draft stopper in chimney
  - 2 Install solar panels, ideally on rear or side of roof
  - 3 Insulate attic
  - 4 Repair and weather-strip historic windows and doors
  - 5 Install interior storm windows
  - 6 Maintain and repair shutters and porches
- 

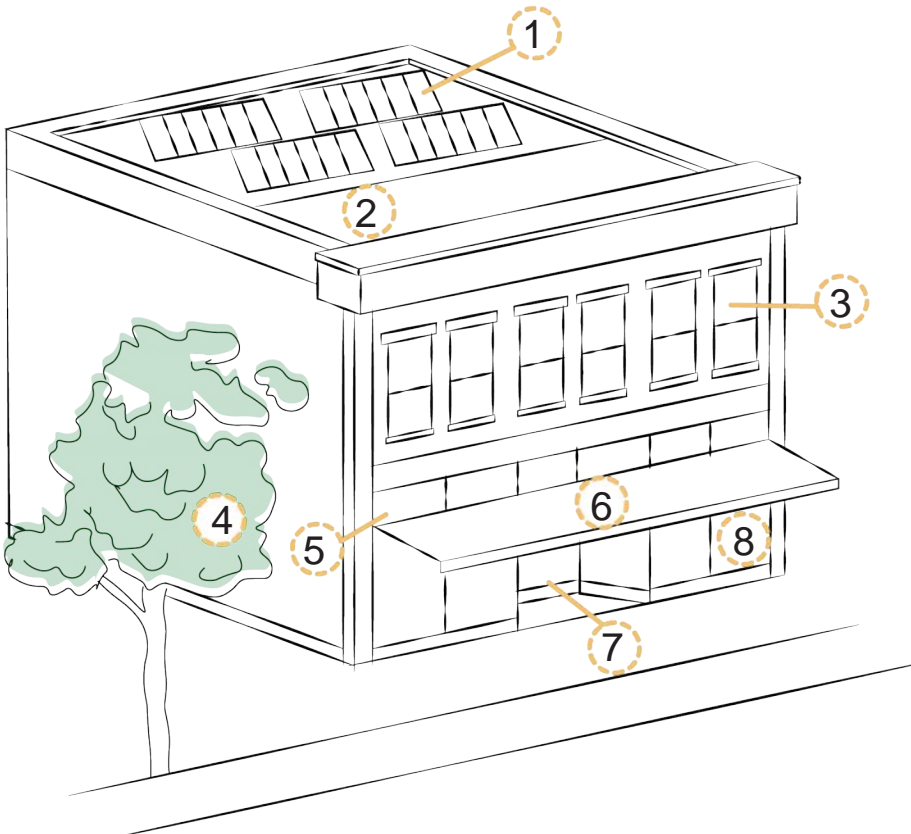

**For historic commercial buildings:**

- 1 Install solar panels, minimizing visibility from the street if possible
  - 2 Insulate attic
  - 3 Install interior storm windows
  - 4 Maintain street trees
  - 5 Repair and weather-strip transom windows
  - 6 Install awnings and/or retain historic canopies
  - 7 Repair and weather-strip historic doors
  - 8 Repair and weather-strip historic windows
-

# Repair and Alterations

General standards 29

Foundations 31

Roofs 33

Exterior walls and trim 35

Windows, doors, and screens 37

Windows and energy conservation 39

Porches 41

Chimneys 43

Attached garages and carports 43

Light fixtures 43

Accessory buildings 43

Commercial storefronts 45

 Meets sustainability goals

## When the standards apply to repair and alterations

Three types of historic properties are regulated through the City of Austin historic review process.

*Do they need to follow these design standards?*

Historic landmarks	✓	
Historic districts	✓	Contributing properties
	~	Noncontributing properties—recommended, not required
National Register districts	~	Recommended, not required



---

Historic preservation prioritizes the retention and repair of as much historic material as possible. This preserves historic building materials that were designed to last decades, are more durable, and are typically more cost-effective in the long run than today's cheaper materials. Historic materials also convey an authentic story of when and how a building was constructed.

When repairing or replacing historic materials, modern materials may be considered if they are durable and have been established not to harm historic material. Using inappropriate modern materials can cause more damage than the repairs themselves.

Consult the **Maintenance and Preservation of Historic Materials** chapter for more detailed information.

Any project that involves changes or additions to the shape of a building is covered in the **Residential Additions** and **Commercial Additions** chapters (for example, adding dormers to a roof to make an attic habitable).

# 1

## General Standards

---

1.1 Do not remove intact historic material from the exterior of a building.



1.2 Always attempt repair first. Replacement should only be undertaken when absolutely necessary, and for the smallest area possible.

1.3 When historic material must be replaced due to damage or deterioration, replacement materials should look the same, perform reliably within the existing construction, and, in most cases, be made of the same material.

1.4 Do not attempt to re-create an architectural detail or element without proof that it existed on the building historically. Documentation can be physical (traces on the building), written (such as building plans), or photographic.

1.5 When demolishing additions or features that were built after the building's period of significance, minimize damage to the building.

a. Stabilize and repair building walls that are exposed when non-historic additions or features are removed.

b. Avoid demolition that removes historic structural systems or compromises the structural integrity of a historic building.



Most historic materials, especially wood, are high-quality old-growth material that cannot be replicated with modern materials of the same quality. If historic materials cannot be repaired, replacement materials should be similar in look, performance, and material.

---

**Resources:**

- [Secretary's Standards for Rehabilitation](#)

## 2 Foundations

A solid foundation stabilizes the building above and creates a key relationship between the building and its site that helps define its historic character.

In Austin, historic buildings are often built on a pier-and-beam foundation. This means the ground-floor framing rests on a series of columns (piers). Piers raise these buildings above the ground to protect them from moisture, provide ventilation, and facilitate maintenance. In older buildings, piers were often made of rot-resistant cedar or cypress posts, which were driven into the ground with sledgehammers. Over time, most buildings have had their wood piers replaced with concrete piers. Many parts of Austin have expansive clay soil that moves as moisture levels vary over time, requiring piers to be driven to a depth of consistent moisture (usually between 4 and 6 feet).

Depending on soil conditions, load-bearing masonry buildings often continued the masonry walls underground to form continuous masonry foundations. Depending on the conditions of the soil, these may require underpinning with reinforced concrete foundations.

Later buildings were typically constructed on concrete slabs reinforced with steel bars. These slab-on-grade foundations rest directly on the soil below.

Demolition of a building with a failing foundation is never the only option. There are foundation repair methods available to address issues with any foundation type.

### *Maintenance*

Foundation repair should be part of the maintenance plan for any historic building in Austin. Talk with a foundation professional about how to improve the foundation to rock-solid (bearing on bedrock) or for an acceptable level of movement. Build interior shear walls to improve the rigidity of the home, which will minimize cracking of drywall and plaster.

Positive drainage (grading to slope the ground away from the building so water does not pond near the foundation) is paramount to the longevity and stability of any foundation system and should be considered when planning improvements.

### *Standards for repair and replacement*

2.1 Maintain the building's historic relationship with the site. Do not raise, lower, or rotate the historic building when rehabilitating the foundation.



2.2 Retain portions of the foundation system visible from the exterior.

- a. Retain and repair masonry building skirts.
- b. Retain and repair historic wood or metal building skirts, where possible. Like roofs, these protective elements may require replacement over time. Replicate historic building skirts when necessary to replace them.

### *Recommendation*

- Because building skirts are in constant contact with the ground, cementitious board is a good choice for a replacement material.
- Stabilize and repair concrete slab foundations with underpinning piers.

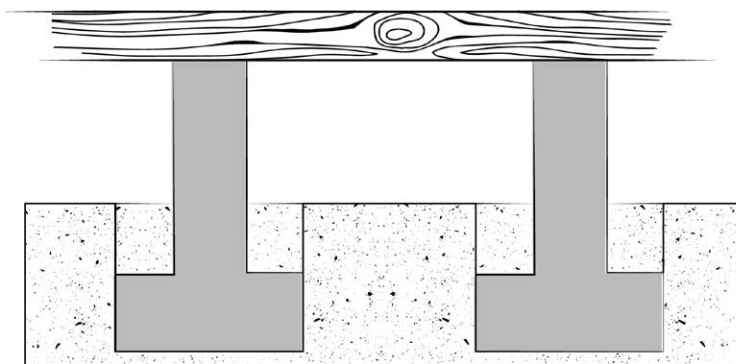

**Pier-and-beam foundation**

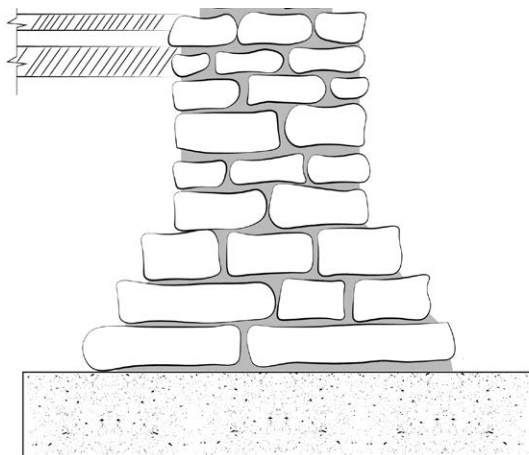

**Masonry foundation**

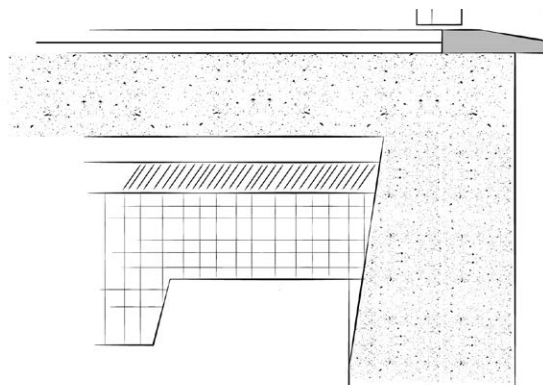

**Concrete slab foundation**

**Above left:** Parts of Austin have clay soils that move based on varying moisture conditions, and early slabs were not always properly reinforced. As a result, many historic slab-on-grade foundations have cracks as a result of settling.

**Above right:** Many historic buildings were built with interior wood shiplap siding covered with cloth and wallpaper. Installation of drywall in pier-and-beam buildings often leads to stress cracks, commonly at the corners of door frames. These should not be used to justify demolition.

**Resources:**

- [Holding the Line: Controlling Unwanted Moisture in Historic Buildings](#) (Preservation Brief 39), National Park Service
- [Walls and Foundations of Historic Buildings](#), Government of the District of Columbia

# 3 Roofs

Roofs are a key character-defining element. Roofing materials will need to be periodically replaced, but a building's historic roof form and pitch should remain the same.

Changing the roof framing system to provide more space in an attic or to create dormers on roofs is discussed in the **Residential Additions** and **Commercial Additions** chapters.

## Maintenance

Regularly monitor and maintain the roof system before leaks impact historic material in the building. Plan financially for roof replacement on a schedule determined by the longevity of the roof material.

## Standards for repair and replacement

3.1 When replacing roof material, use a material that is appropriate to the building's history and character. Metal roofs are acceptable in historic districts unless addressed in a supplement to these standards.

3.2 When replacing roof material, retain the configuration; pitch; soffit detailing; character-defining features such as chimney, gutters, and ventilation systems; and design, configuration, and detailing of eaves.

 3.3 Retain and repair historic decorative roof elements such as exposed rafter ends, bargeboards, brackets, and cornices. If elements are damaged beyond repair, replace them in-kind.

3.4 Do not add decorative roof elements that were not historically present.

## Additional standards for historic landmarks

3.5 Owners of landmark properties must replace roofs with material that approximates the appearance of the historic or existing roof material.

- a. When planning a roof replacement, research the history of the building and solicit input from the Historic Preservation Office to determine the most appropriate roof material.

- b. Consider using the historic roof material, if feasible.

- c. Fiberglass or composition roof systems are acceptable, if they approximate the historic roof material in appearance.

- d. Standing seam metal roofs, despite their historic look, are generally not acceptable for historic landmarks unless the owner can document that the building historically had a standing seam roof. Metal roof systems that replicate the historic roof material and have a historic appearance are acceptable.

## Recommendations

- Where possible and practicable, locate solar panels on a rear-facing roof slope so that they are not visible from the street.
- If a building does not have gutters, install them to prevent rain from splashing against the bottom of walls. Where gutters are not historically appropriate, use grading and stone landscape perimeters to minimize backsplash.

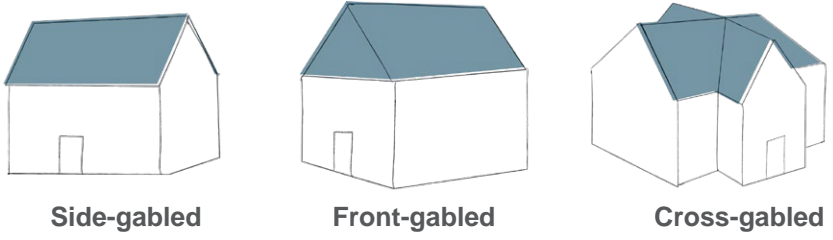
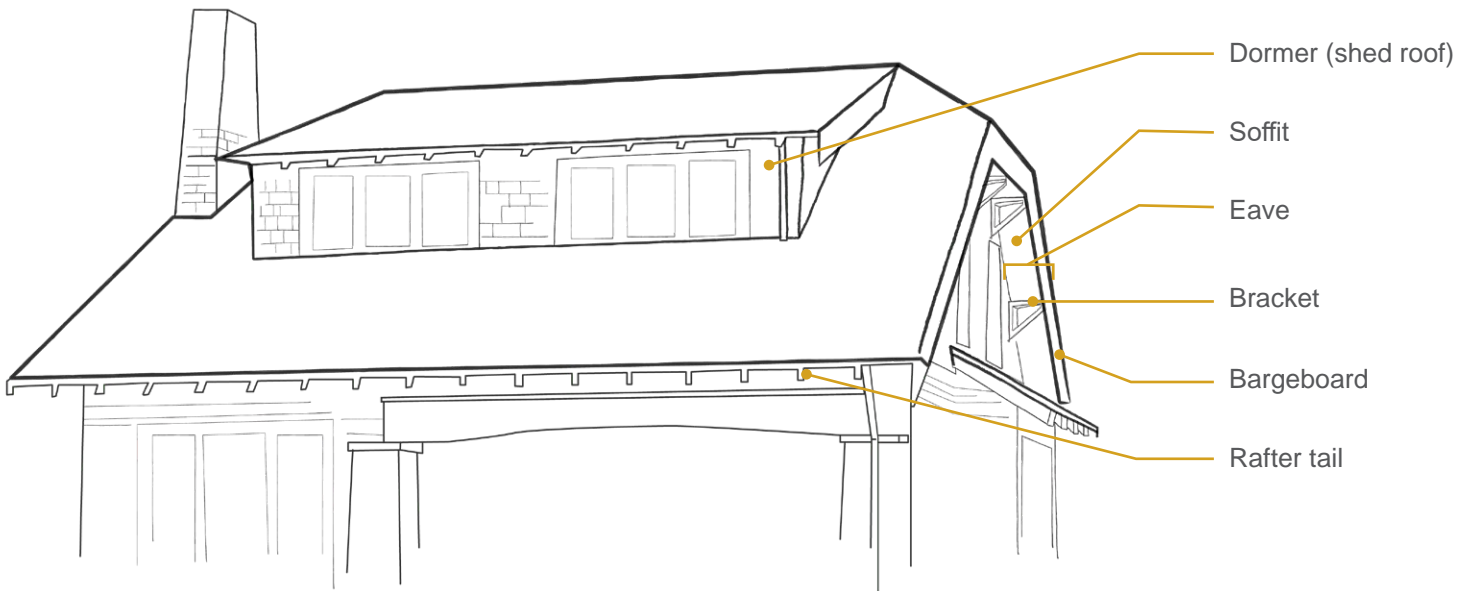

**Side-gabled**

**Front-gabled**

**Cross-gabled**

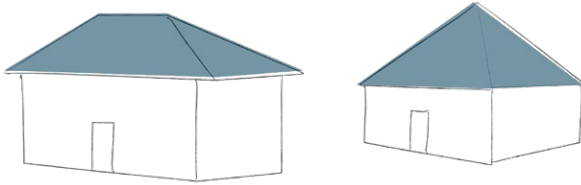

**Hipped**

**Pyramidal**

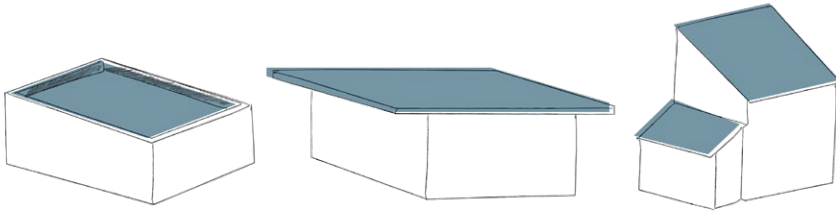

**Flat with parapet**

**Flat**

**Shed**

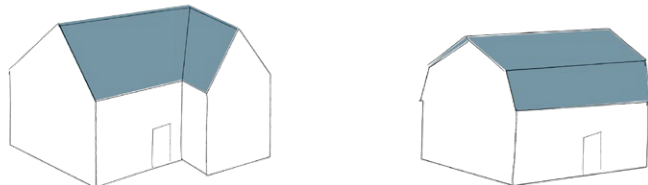

**Wing-and-gable**

**Gambrel**

Roofs can be highly ornamented or have only minimal decorations, depending on the building's style and the resources of the people who built it.

A building's roof form depends on when it was constructed, its architectural style, and the materials available at the time.



Solar panels can be compatible with historic character.

**Resources:**

- [Roofing for Historic Buildings](#) (Preservation Brief 4), National Park Service

## 4

## Exterior Walls and Trim

Exterior siding is a prominent character-defining feature. The materials selected for a building document the priorities and sometimes the skills of the owner and builder, as well as the evolution of materials over time. Trim conceals transitions between construction materials and helps to visually define the main features of a building's design.

### Maintenance

Proper maintenance of exterior walls and trim is key. Most importantly, an exterior coat of paint is the first line of defense and preservation for wood siding and trim. Painting masonry is discouraged: it changes the appearance of a historic building and prevents the wall from drying properly, causing masonry units to deteriorate from the inside.

Whether wood, masonry, or stucco, walls should be protected from moisture. Where possible, install gutters to prevent rain from falling around a building's perimeter and splashing back against the bottom of the wall. Use diverters to prevent overflow in problem areas that generate heavy runoff from the roof. In some cases, gutters might not be historically appropriate; grading and stone perimeters can minimize backsplash and keep the lower walls clean.

While these standards do not proscribe non-permanent landscaping, owners are advised to plant shrubs and vines away from a building, since plant contact introduces moisture, and prevent automatic sprinklers from spraying water onto the building. This will give room for the walls to breathe and stay dry, preventing secondary biogrowth such as mildew or mold that can damage historic building materials.

### Standards for repair and replacement

-  4.1 Repair, rather than replace, historic material, unless it is deteriorated beyond the point of stabilization or restoration. Replace only those portions of an exterior wall or trim that are deteriorated beyond repair, leaving the rest of the wall or trim intact.
- 4.2 When replacement or patching is required, use a compatible material that has a matching profile

and texture, and that will not damage the historic material. Rot-resistant materials of similar density may be considered (e.g., cementitious siding).

- 4.3 When repointing a masonry wall, use replacement mortar that matches the historic mortar in composition, joint profile, and color.
- 4.4 When cleaning masonry, use gentle techniques that do not damage the wall.
- 4.5 Minimize changes to side walls that are visible from streets (not including alleys).
- 4.6 Removal and replacement of exterior cladding and trim for additional insulation is discouraged but allowed in historic districts. The reinstalled cladding and trim should reflect the historic dimensions and location to the greatest degree possible.

### ★ Additional standards for historic landmarks

- 4.7 Obtain historic approval before changing exterior paint colors or painting unpainted masonry.
- 4.8 Do not remove or replace exterior cladding and trim for additional insulation.

### Recommendations

- Treat deteriorating wood with consolidating materials like epoxy resin using preservation industry standards.
- When replacement or patching is required, use an exact matching material such as old-growth wood or matching masonry.
- When it is necessary to remove historic material for work, remove it carefully, number it, and replace it in its original location.





Wood is the most common type of siding in Austin, as it was easily milled into different shapes, with profiles that changed along with architectural styles.

---



Brick is a local material often used to construct prominent homes and commercial buildings.

---

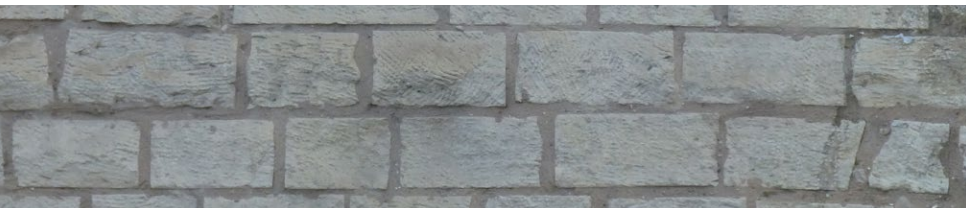

Local limestone was used for commercial buildings, as well as some houses.

---



Stucco was used as a character-defining element of some revival styles in the early 20th century.

---



Asbestos (left) and aluminum (below) may be original siding types in mid-century buildings. These should be maintained or replaced with material that matches in dimensions and texture.

---



**Resources:**

- See the **Maintenance and Preservation of Historic Materials** chapter for information about the treatment of exterior materials.

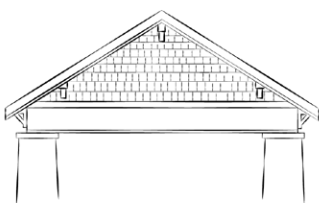

**Craftsman**



**Queen Anne**



**Tudor Revival**

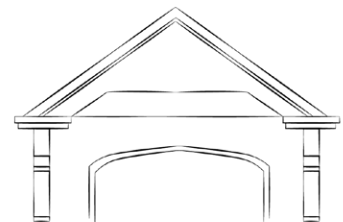

**Classical Revival**

Elaborate trim helped to define the different architectural styles during the revival era of the early 20<sup>th</sup> century. Trim on Mid-Century and Ranch-style buildings is typically more spare, but still important in defining each building's style.

# 5 Windows, Doors, and Screens

The design of windows, doors, and screens are as varied as Austin's historic buildings. These important elements range from utilitarian to ornamental, and each helps tell the story of a building. Because each element added both function and design, windows, screens, and doors are essential character-defining features.

Historic doors are often the focal point of a building's design. In Austin, multiple doors in a building were often used to provide added ventilation or flexible use.

## Maintenance

Historic windows and doors were designed to be adjustable and easily repairable. A property owner or tenant with basic carpentry skills can install and rehabilitate wood sashes, glass installed with glazing compound, and metal fin weather-stripping. Finding a contractor familiar with historic windows is important for larger or more complex projects. For both do-it-yourself owners and professionals, window parts are readily available to replace deteriorated elements.

## Standards for repair and replacement

- 

5.1 Repair, rather than replace, historic windows, doors, and screens; and their trim, surrounds, sidelights, transoms, and shutters, unless they are deteriorated beyond the point of stabilization or restoration. Retain windows if 50% or more of the wood or metal sash members are intact.

  - a. Using modern material in repairs and patches is a possibility if the material has proven appropriate and stable in similar uses.
- 

5.2 Historic windows on non-street-facing walls may be replaced for energy efficiency if other high-impact energy efficiency upgrades have been completed or are included in the same project. All following standards for replacement windows apply.
- 5.3 If historic windows must be replaced, match the size and details of the existing window, including configuration, profile, and finish. Take into account elements such as frames, sashes, muntins, sills, heads, moldings, surrounds, hardware, and shutters.
- a. If a window has divided lites, replacement windows must have true divided lites or simulated divided lites with dimensional muntins placed on the outside of the glass and corresponding spacers of an appropriate color, material, and thickness on the inside of the glass, so that the window appears to have true divided lites.
- b. Never use a replacement window with false muntins inserted inside the glass.
- c. In historic districts, there is more flexibility for windows not visible from a front or side street.
- 5.4 If historic windows visible from a front or side street must be replaced, relocate historic windows from a non-street-facing wall, if sizes allow.
- 5.5 Do not enlarge, move, or enclose historic window or door openings that are highly visible from a front or side street. It may be appropriate to restore historic door or window openings that have been enclosed.
- 5.6 If adding windows or doors is necessary, create new openings on a wall not visible from the front street.
- 5.7 If replacing a non-original door, identify the historic style of the door through research, or look to nearby similar properties to guide the choice of a replacement.
- 5.8 If a historic window or door is missing, replace it with a new unit based on documentation of the historic feature. If no documentation exists, use a new design compatible with the historic opening and the historic character of the building.

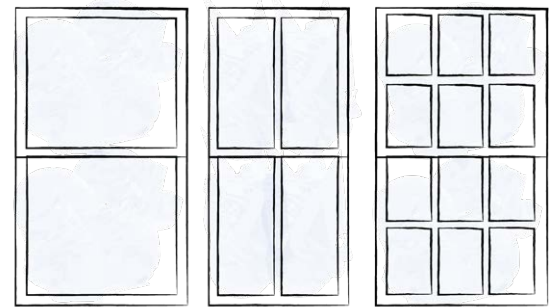
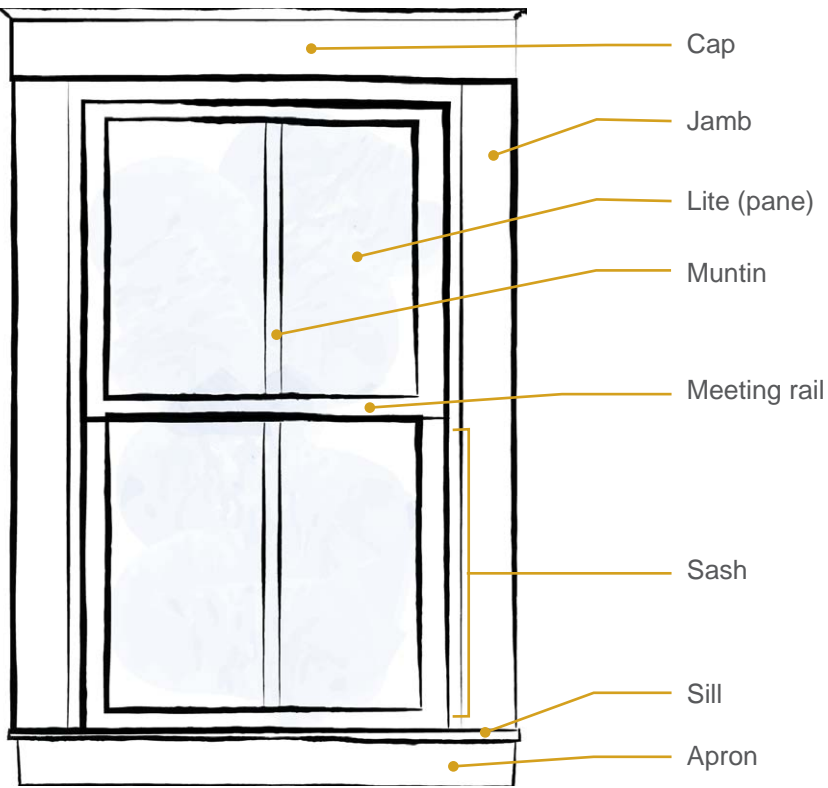

1-over-1

2-over-2

6-over-6

**Above:** The window type and number of lites, or panes of glass, in a window speak to a building's construction period and architectural style. Early windows are typically 1-over-1 or 2-over-2 double-hung wood-sash windows; the 6-over-6 lite pattern appeared in the 1930s and 40s. Sometimes window screens added ornamentation by making windows appear to contain more lites.

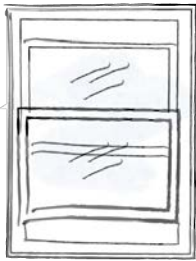

Double-hung

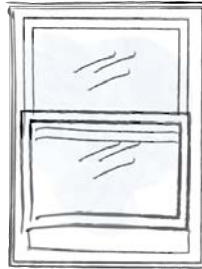

Single-hung

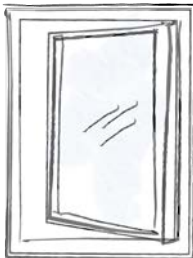

Casement

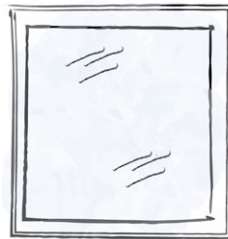

Fixed

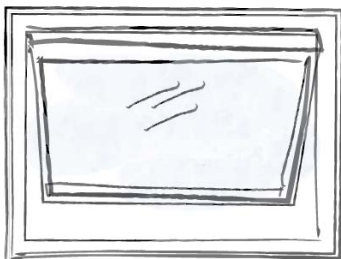

Awning

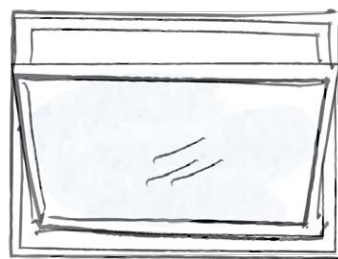

Hopper

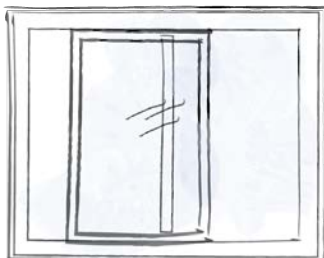

Sliding



Jalousie

## 5

## Windows, Doors, and Screens (con't)

- 5.9 If adding window screens to a building that did not have them during its period of significance, select a thin-profile frame.
- 5.10 If adding a screen door over a historic door, use a period-appropriate screen door or a frame with a clean, minimal profile and transparent screen that does not obscure the door behind.
- 5.11 Do not add shutters if there is no evidence that they existed during the building's period of significance. If reconstructing or replacing historic shutters, select a replacement that matches what was there in size, design, and materials.
- 5.12 If installing security bars or grates where they did not exist historically, select a type that minimizes visual impact on the building and install them in a way that does not damage historic materials.

 *Additional standards for historic landmarks*

- 5.13 Do not enlarge, move, or enclose any historic window or door openings unless required by an addition. If an opening is being used to connect to an addition, retain the size and configuration of the opening to the greatest extent possible.
- 5.14 New door or window openings must be limited, appropriate for the building, and compatible with the architectural character.

- 5.15 Do not replace historic windows; repair them except in cases of extreme damage or deterioration. Replace in-kind if necessary.

*Recommendations*



- When doors and windows are partially deteriorated, consolidate (stabilize with epoxy resin) or reinforce deteriorated elements.
- When doors and windows are extremely deteriorated, replace or patch deteriorated elements with an exact matching material such as reclaimed old-growth wood or steel.
- If adding screens and the detailing around a window suggests it had wood screens, build reproduction screens. Use neighboring historic properties and historic photos as guidelines for the design.
- Use transparent screen material for window screens on front and front side walls.
- Most historic hardware is metal and can be refurbished and reused. Even if the door or window is new, use hardware that reflects the era, style, and finish of the building.
- Provide security at the perimeter of a property or through monitoring and alarm systems or install security bars on the interior of a window or door, so they are not visible from the exterior.

## Windows and Energy Conservation

Windows are often replaced out of concern for energy efficiency. However, equivalent energy can be saved—often with a better return on investment—by weather-stripping, sealing joints and cracks, installing more efficient heating and cooling equipment, insulating the roof, installing solar screens in existing frames, and adding interior storm windows. The design standards recommend making these high-impact, high-return improvements before replacing historic windows. See the **Modern Codes and Energy Efficiency** chapter for more information.

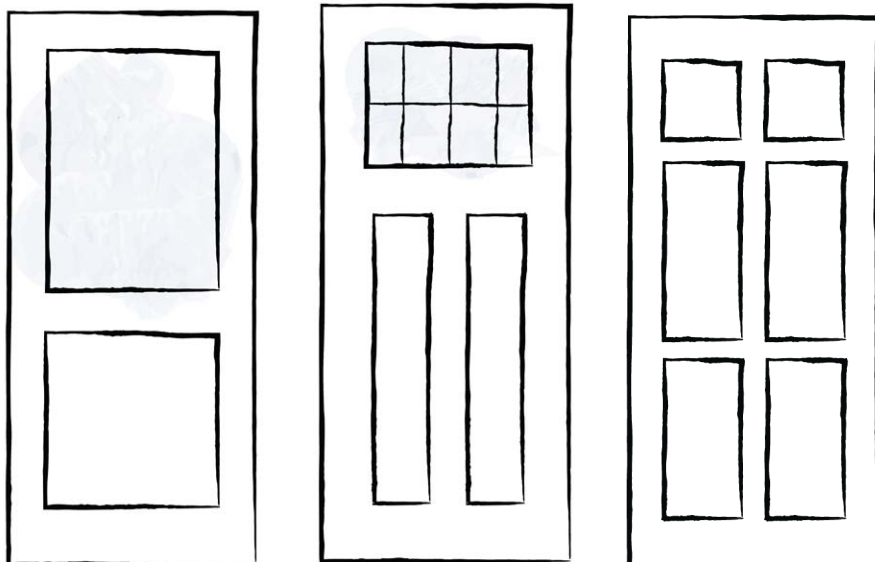
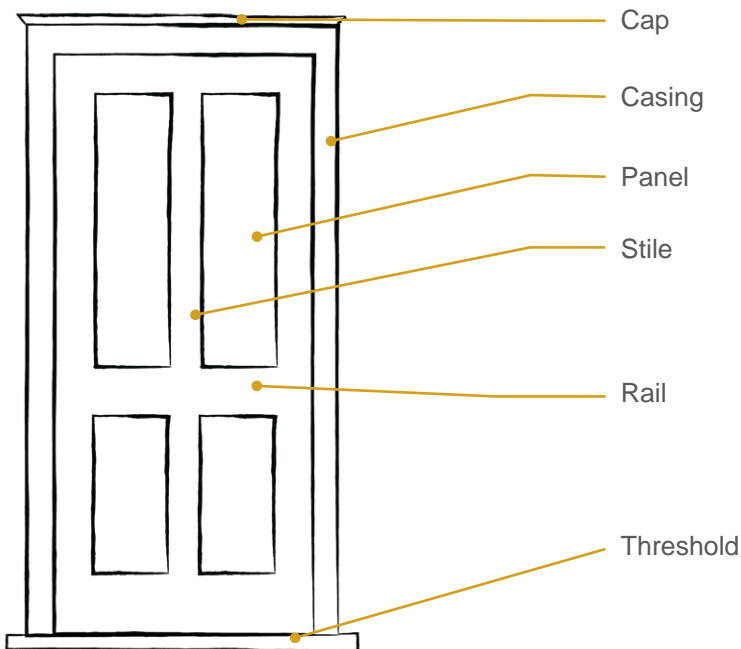

Paneled and partially glazed

Paneled

**Above left:** Wood-sash windows can be repaired by a homeowner with training and online resources.

**Above right:** Weatherstripping and interior storm windows substantially reduce air flow.

**Resources:**

- [The Repair of Historic Wooden Windows](#) (Preservation Brief 9), National Park Service
- [Preservation Tech Notes on windows](#), National Park Service (scroll down)
- [The Repair and Thermal Upgrading of Historic Steel Windows](#) (Preservation Brief 13), National Park Service
- [Window Preservation Standards](#), Window Preservation Standards Collaborative
- [Inappropriate Replacement Doors](#) (Interpreting the Standards 4), National Park Service
- [Adding New Entrances to Historic Buildings](#) (Interpreting the Standards 22), National Park Service

# 6 Porches

Porches provided a cool living space before modern air conditioning systems—an especially important role in Austin due to climate. A porch is usually an important character-defining feature.

---

## Maintenance

Regularly inspect historic porches and address issues immediately, before any deterioration worsens. For wood porches, proper drainage and a well-maintained coat of paint are the first line of defense against deterioration.

## Standards for repair and replacement

- 6.1 Repair, rather than replace, historic porch decking, piers, columns, railings, skirting, and trim, unless they are too deteriorated.
- 6.2 If it is necessary to replace historic elements, use compatible material with matching dimensions and details. Compatible materials include wood, rot-resistant material, or matching masonry or concrete.
- 6.3 Maintain porch dimensions and height.
- 6.4 Maintain the open nature of front porches.
  - a. If enclosing a porch with screening, use reversible attachment methods.
  - b. Do not enclose a front porch with solid materials such as wood or glass.

6.5 Preserve the historic railing style. Do not replace an open railing with a solid wall unless one historically existed.

6.6 If a railing must be made higher for life safety purposes, retain the historic railing and add a visually light element at the required height that minimizes its appearance (e.g., glass or a narrow higher railing).

## Recommendations

- When porch elements are partially deteriorated, consolidate (stabilize with epoxy resin) or reinforce them.
- When porch elements are extremely deteriorated, replace or patch them with an exact matching material such as reclaimed old-growth wood.

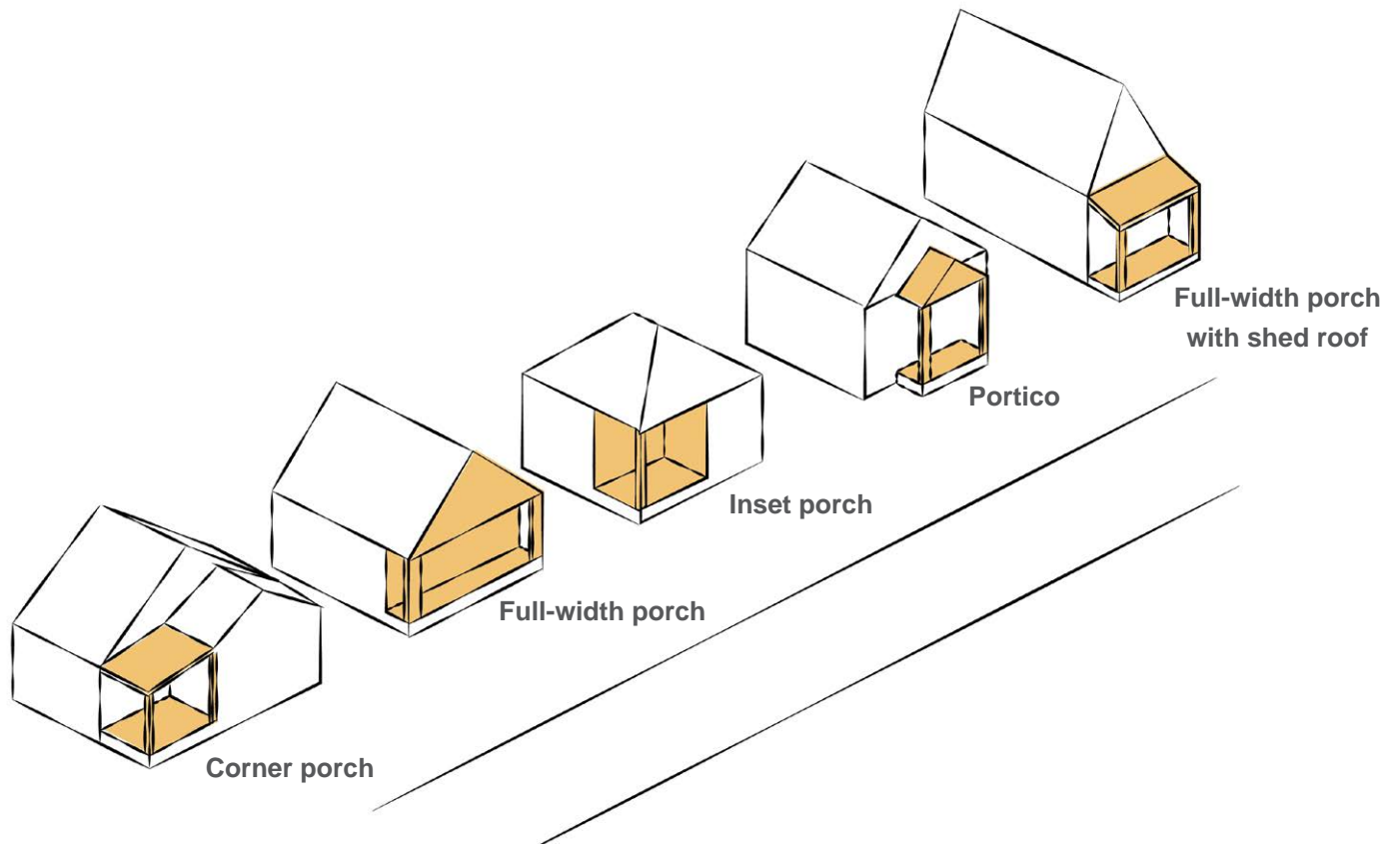

Front porches provide the first opportunity to make an impression on visitors.



**Resources:**

- [Preserving Historic Wooden Porches](#) (Preservation Brief 45), National Park Service
- [Inappropriate Porch Alterations](#) (Interpreting the Standards 9), National Park Service

## 7 Chimneys

*Standard for repair and replacement*

7.1 If the chimney is a character-defining feature of a building, it must be repaired or replaced with a

matching design, elements, and materials. If the chimney is not a character-defining feature, it may be removed and not replaced.

## 8 Attached Garages and Carports

*Standards for repair and replacement*

 8.1 Retain historic attached garages and carports and their character-defining features, such as principal materials, roof materials, roof form, windows, window and door openings, and architectural details.

8.2 If replacement of character-defining features is necessary, select replacements that match the original as closely as possible in material, texture, size, and finish.

8.3 Conversion of attached carports into enclosed garages or living space, or garages into living space, is allowed in historic districts.

- a. Recess the infill of the carport's front wall six inches at minimum.
- b. When infilling a carport, use exterior siding and window sizes and materials that are similar to and compatible with the historic building. Include at least one window on the front wall.

## 9 Light Fixtures

*Standards for repair and replacement:*

-  9.1 Retain and repair historic light fixtures.
- 9.2 If historic light fixtures must be replaced, use a fixture that matches the historic fixture as closely as possible or a modern light fixture that does not distract from the streetscape or building's historic character.

*Recommendations*

-  • Use energy-efficient LED bulbs in existing fixtures where possible.
- If adding a light fixture where none exists, use a fixture that reflects the building or neighborhood's style and period of construction.

## 10 Accessory Buildings

Based on their importance to a particular historic district, accessory buildings can be addressed in a supplement to the design standards. They are evaluated on a case-by-case basis for their importance to a historic landmark.

*Standard for repair and replacement*

-  10.1 Whenever possible, retain and repair existing historic accessory buildings.





**Above:** Light fixtures like this historic green lamppost help define a street's character. They are typically representative of a given owner or builder, as well as a specific time and place.



**Left:** This converted carport adds living space in a compatible way. Under these design standards, it would need to be recessed 6" from the front wall.



Evolving automobile design, changes to families, and urban homesteading created a variety of accessory building designs.



**Resources:**

- [Maintaining the Exterior of Small and Medium Size Historic Buildings](#) (Preservation Brief 47), National Park Service

# 11 Commercial Storefronts

Austin has several distinctive areas of early twentieth century and mid-century commercial blocks. Many of these commercial buildings have unique character-defining elements that should be preserved regardless of changes in use. An older commercial storefront that is preserved can boost the vibrancy and desirability of its surrounding area and increase the economic success of its business and neighboring businesses.

## *Standards for repair and replacement*



- 11.1 Repair, rather than replace, historic storefront elements.
- 11.2 Retain historic window and door openings.
- 11.3 When working on a storefront that has been substantially altered or removed, use a design and materials that are compatible with the scale and style of the building.
- 11.4 Use clear glass in storefront windows to maintain transparency.
- 11.5 If reconstructing a historic canopy or awning, replace it based on documentation of the historic feature.
- 11.6 Design new canopies and awnings to be compatible with the scale, style, materials, and proportions of the building.
  - a. Ensure that new canopies and awnings do not obscure or damage architectural features of historic buildings.
  - b. Differentiate the new canopy or awning from any historic canopies or awnings through style, materials, and/or other design elements.



## *Additional standard for historic landmarks*

- 11.7 Do not add canopies or awnings to the front of a historic landmark unless physical, photographic, or plan evidence exists that they were historically present.

## *Recommendations*

- Restore an altered storefront to its design during the period of significance where documentation exists.
- Reconstruct missing features where documentation exists.
- Simple canvas awnings are appropriate and encouraged for buildings in historic districts.

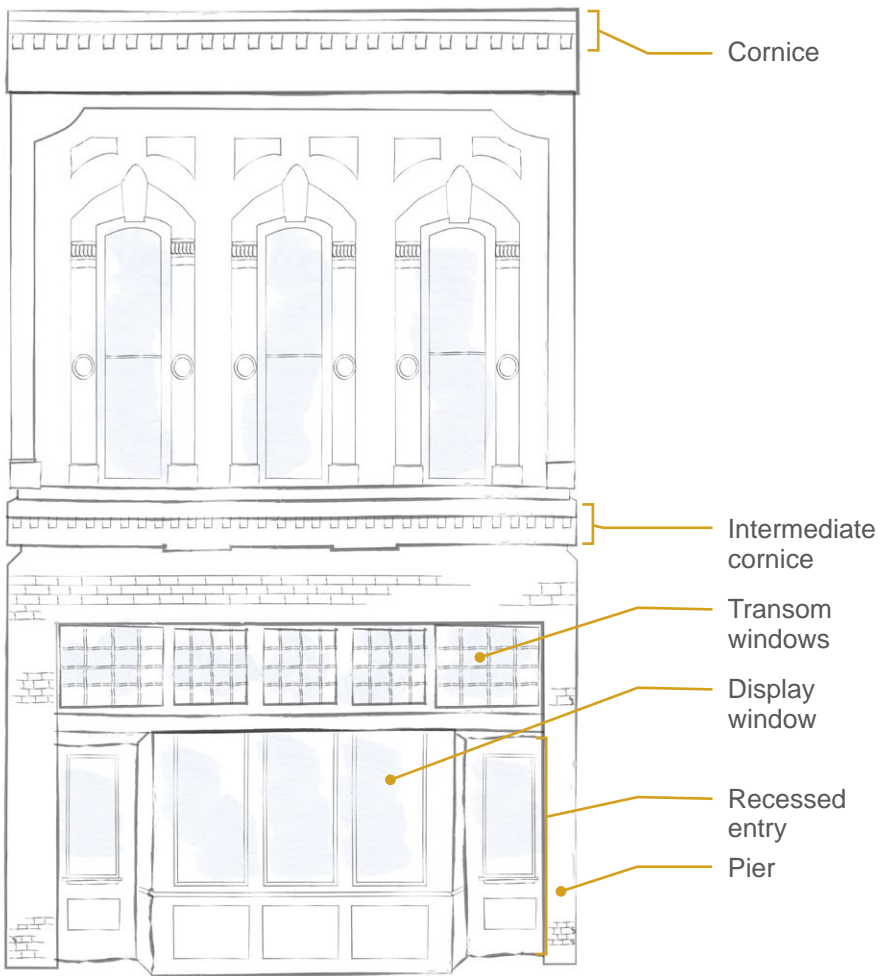

Like other buildings, commercial storefronts can have more or less elaborate designs, depending on when they were built, where they were located, and the means of the property owner.

---



A storefront that has been altered can be reconstructed, if historic documentation exists, or rehabilitated in a more modern style that recognizes the building's historic character. Reconstruction standards are higher for historic landmarks.

---

**Resources:**

- [Rehabilitating Historic Storefronts](#) (Preservation Brief 11), National Park Service
- [Repair/Replacement of Missing or Altered Storefronts](#) (Interpreting the Standards 13), National Park Service
- See the **Maintenance and Preservation of Historic Materials** chapter for additional information about the treatment of exterior materials.

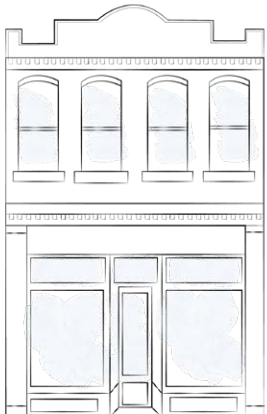

**Reconstruction**

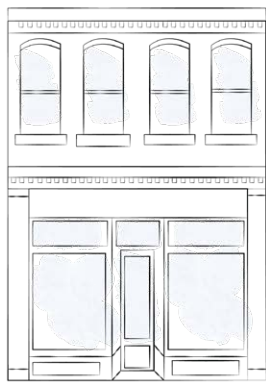

**Simplified historic interpretation**

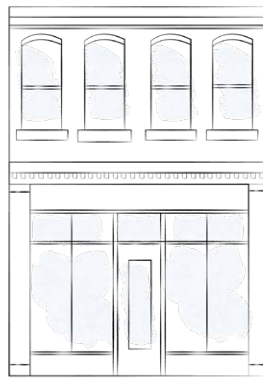

**Contemporary interpretation**

# Residential Additions

Location 49

Scale, massing, and height 49

Design and style 51

Roofs 53

Exterior walls 53

Windows, screens, and doors 53

Porches and decks 55

Chimneys 55

Attached garages and carports 55

 Meets sustainability goals

## When the standards apply to residential additions

Three types of historic properties are regulated through the City of Austin historic review process.

*Do they need to follow these design standards?*

Historic landmarks	✓
Historic districts	✓ Contributing properties
	~ Noncontributing properties—recommended, not required
National Register districts	~ Recommended, not required

---

An addition's location, size, scale, design, and materials should preserve the character of the historic house and site. An addition's impact can be reduced by locating it to the rear or side and designing it to be visually subordinate.

# 1 Location

Locate additions so that they do not visually overpower the existing building, compromise its historic character, or destroy significant features or materials.

## Standards

- 1.1 Locate additions to the rear and sides of historic buildings to minimize visual impact.
- 1.2 Step back side additions from the front wall a distance that preserves the shape of the historic building from the primary street.
- 1.3 If an addition adds a story to the historic building, set it back from the front wall to minimize visual impact.
  - a. If the historic building has a side-gabled, cross-gabled, hipped, or pyramidal roof form, set the addition behind the roof ridgeline or peak.
  - b. If the historic building has a front-gabled, flat, or shed roof form, set the addition back from the front wall the greater of 15' or one-half of the width of the front wall.

- 1.4 For corner properties, set back the addition to align with or behind the front setback of the adjacent building fronting on that street. If the addition faces a street without an adjacent building fronting on it, this standard does not apply.



- 1.5 Minimize the loss of historic fabric by connecting additions to the existing building through the least possible invasive location and means.



## Additional standard for historic landmarks

- 1.6 Additions are not appropriate for all historic landmarks and will be evaluated on a case-by-case basis.

## Recommendation

- Locate additions behind the rear wall of the historic building.

# 2 Scale, Massing, and Height

## Standards

- 2.1 Design an addition to complement the scale and massing of the historic building, including height. The addition must appear subordinate to the historic building.
- 2.2 Minimize the appearance of the addition from the street faced by the historic building's front wall.
  - a. If the addition connects to the historic building's rear wall, step in the addition's side walls at least one foot (1') from the side walls of the historic building.

- b. The historic building's overall shape as viewed from the street must appear relatively unaltered.

## Recommendations

- Design one-story additions to one-story buildings.
- Minimize the roof height of multi-story additions.
- Construct a large addition as a separate building and connect it to the historic building with a linking element such as a breezeway or a hyphen.

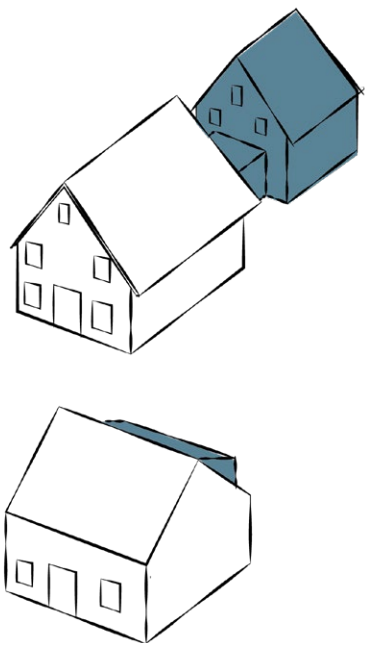

Compatible additions are subordinate to the historic building.

---

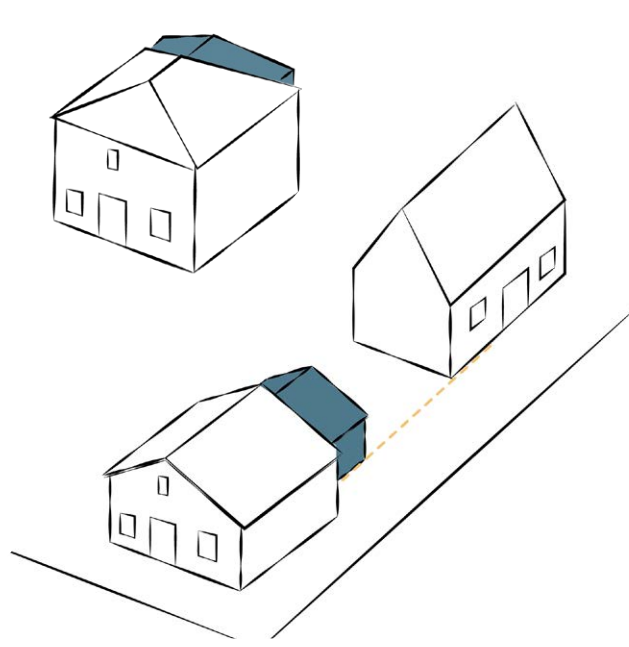

Incompatible additions compromise the design and form of the historic building.

---

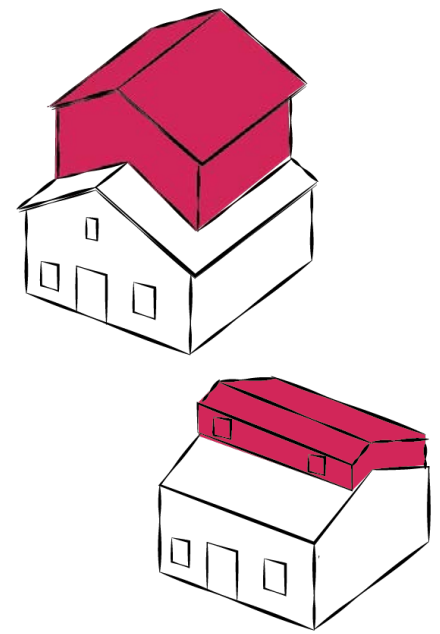

Avoid additions that would require removing or damaging significant architectural elements or site features such as protected trees.

---



For additions to buildings with front-gabled, flat, or shed roofs, if the front wall is thirty feet (30') wide, set the addition back by at least fifteen feet (15').

---

**Resources:**

- [New Exterior Additions to Historic Buildings](#) (Preservation Brief 14), National Park Service
- [Rear Additions to Historic Houses](#) (Interpreting the Standards 37), National Park Service

# 3 Design and Style

To preserve a property's historic character, an addition must be visually distinguishable from the historic building. This does not mean that the addition must be glaringly different in terms of design, materials, and other visual qualities. It simply means it should take its design cues from the historic building.

---

## Standards

- 3.1 Design additions to be compatible with and differentiated from the historic building, if they are visible from the street.
- a. Design proportions and patterns such as window-to-wall area ratios, floor-to-floor heights, fenestration patterns, and bay divisions to increase compatibility.
  - b. Do not replicate the design or details of the existing building to a degree that the addition might be mistaken as historic.
- 3.2 No particular architectural style is required for addition design. Designs in both traditional and contemporary styles can successfully achieve compatibility and differentiation with historic buildings.

- 3.3 If adding dormers to the roof of a historic building, do not locate them on front-facing slopes. Minimize their location, size, and scale on side-facing slopes.

## Recommendation

- Create usable upstairs space by constructing upstairs dormers on a rear or side-facing roof slope.





Historic buildings may have additions designed in contemporary or modern styles.

This addition is connected by a rear hyphen to the historic building, a best practice. An addition can also be differentiated through a different architectural style or a change in roofline, cornice height, wall plane, materials, siding profile, and/or window type.



This addition faces the street but is set back from the historic building.

**Resources:**

- [New Exterior Additions to Historic Buildings](#) (Preservation Brief 14), National Park Service
- [New Additions to Mid-Size Historic Buildings](#) (Interpreting the Standards 18), National Park Service

## 4 Roofs

---

### Standards

- 4.1 If an addition will be visible from a street on the front or side, design its roof form and slope to complement the roof on the historic building.
- 4.2 Use roof materials that match or have similar color, texture, and other visual qualities as the roof on the historic building.

## 5 Exterior Walls

---

### Standards

- 5.1 If an addition will be visible from a street on the front or side, use exterior wall materials that are compatible with those on the historic building, as well as with the character of the district, in scale, type, material, size, finish, and texture.
- 5.2 Differentiate the exterior wall materials of the addition from those of the historic building. This could be accomplished by using different materials, using the same materials with different dimensions, or changing trim type or dimensions.
- 5.3 Avoid windowless walls facing a street, unless such walls are a character-defining feature of the historic building.

## 6 Windows, Screens, and Doors

---

### Standards

- 6.1 If an addition will be visible from a street on the front or side, use windows that are compatible with those on the existing building in terms of material, fenestration pattern, size, proportion, configuration, and profile.
- 6.2 Do not use windows with false muntins inserted inside the glass.
- 6.3 If metal screens are used over addition windows, minimize their visual presence with coated or other non-shiny frames.
- 6.4 If an addition's entrance will be visible from the street on the front or the side, use a door that is compatible in terms of size and proportion with those on the existing building.

### Recommendation

- Choose doors that are of a simple design so that they do not detract from the historic building's main entrance.

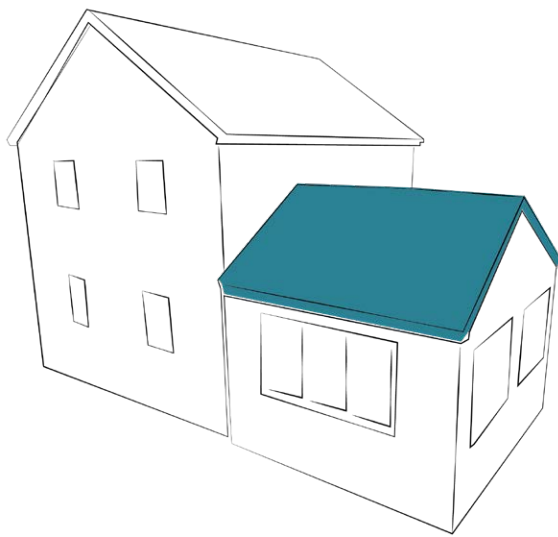

A simple roof form on an addition can complement the roof of the historic building.

---



Siding on an addition should be compatible with and slightly differentiated from the historic building.

---



Window openings with similar heights help this addition relate to the historic building.

---

**Resources:**

- [New Exterior Additions to Historic Buildings](#) (Preservation Brief 14), National Park Service

## 7 Porches and Decks

---

### *Standards*

- 7.1 Do not add porches or decks to the front of a historic building unless physical, photographic, or plan evidence exists that the feature was historically present.
- 7.2 If new back porches and decks will be visible from the street, design them to be compatible with the historic building in terms of size, style, materials, and proportions.

## 8 Chimneys

---

### *Standards*

- 8.1 If a chimney on an addition will be visible from the street, design it to be compatible with both the historic building and the addition in terms of size, style, materials, and proportions.
- 8.2 Do not construct a box chimney or enclose a chimney with wood or wood-like siding.

## 9 Attached Garages and Carports

---

### *Standards*

- 9.1 Construct a new attached garage or carport at the front only if it matches the predominant garage placement and orientation found on the block's contributing properties and is appropriate to the building's form and style.
- 9.2 Set attached garages and carports back from the front wall of the building to minimize their visual prominence.
- 9.3 Design a new attached garage or carport to be compatible with the historic building in terms of

size, massing, proportions, style, and materials.

The new garage or carport should not be designed to appear as though it was constructed simultaneously with the historic building.

- 9.4 Do not expand an attached one-car garage to a two-car garage. A carport may be added if it is compatible with the form, massing, proportions, and style of the historic building.

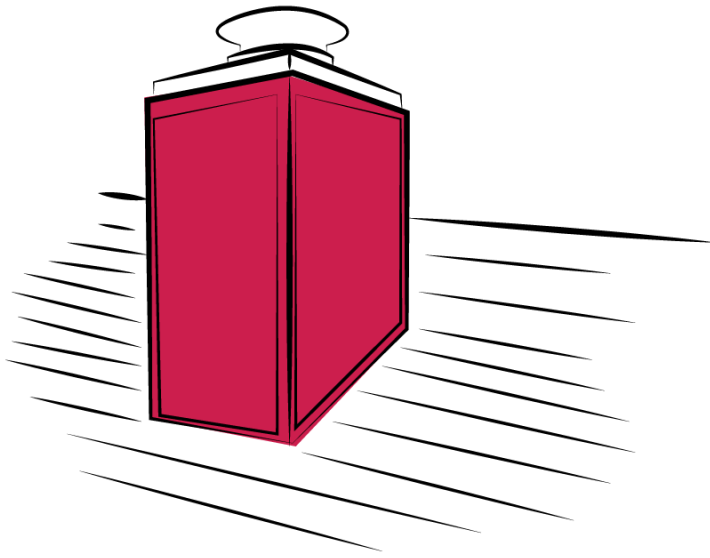

Do not construct box chimneys enclosed with siding.

---

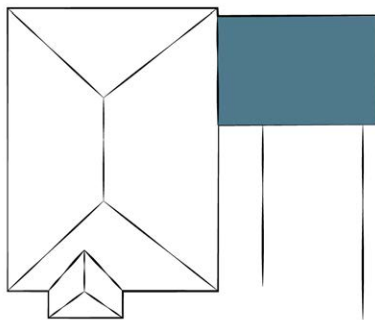

A new attached carport or garage must be set back substantially from the front wall and have a minimal visual impact on the building's historic character.

---

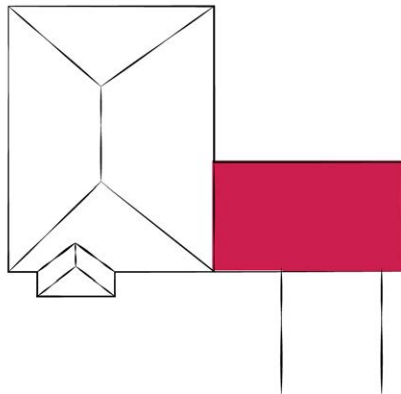

This carport addition to a garage apartment (left) is visually light and subordinate to the historic house.

---

**Resources:**

- [New Exterior Additions to Historic Buildings](#) (Preservation Brief 14), National Park Service

# Residential New Construction

Location 59

Orientation 61

Scale, massing, and height 61

Proportions 63

Design and style 63

Roofs 65

Exterior walls 65

Windows and doors 65

Porches 67

Chimneys 67

Attached garages and carports 67

## When the standards apply to residential new construction

Three types of historic properties are regulated through the City of Austin historic review process.

*Do they need to follow these design standards?*

Historic landmarks ✓

Historic districts

✓ Contributing properties

✓ Noncontributing properties

National Register  
districts

~ Recommended, not required

---

The scale and massing of a new building are essential to maintaining a property or historic district's distinctive character—more so than architectural style or decorative details. However, well-designed stylistic and decorative elements and compatible building materials can help new construction to blend into the character of the street. In historic districts, carefully study both the property and the block when designing a new infill building, and consider street setbacks, parking patterns, porch locations, building heights and materials, roof forms, and windows.

In residential neighborhoods, garage apartments, granny flats, or accessory dwelling units (ADUs) can create smaller, more affordable rental units and provide workforce housing close to jobs. Detached garages and accessory buildings add utility to a property while maintaining the development patterns of a historic district.

The standards apply to all sides of a new building, but there is more flexibility for walls that are not visible from the street, particularly in historic districts. In historic districts, the standards do not apply to new buildings located at the rear or side of the property if the buildings are not visible from the front or side street (regardless of vegetation, though these buildings must still go through historic review).

# 1 Location

Locate new buildings so that they do not visually overpower existing historic buildings or compromise the historic character of the district.

---

## *Standards*

- 1.1 Set back a new primary building from the street in line with nearby historic buildings. An appropriate setback may be calculated with the following:
  - a. The setback of one adjacent contributing historic building; or
  - b. The median of contributing historic buildings on the same block. This method must be used if contributing buildings on the block have a variety of setbacks.
- 1.2 Locate a new building to maintain the rhythm of contributing buildings on the street.

- 1.3 Locate accessory buildings in a way that follows the historic location and setback patterns of similar buildings on the block or in the district. Garage apartments, detached garages, and other accessory buildings are typically located at the rear of the lot, behind and to the side of the front building.

## *Recommendation*

- Minimize the appearance of a new accessory building from the primary street.



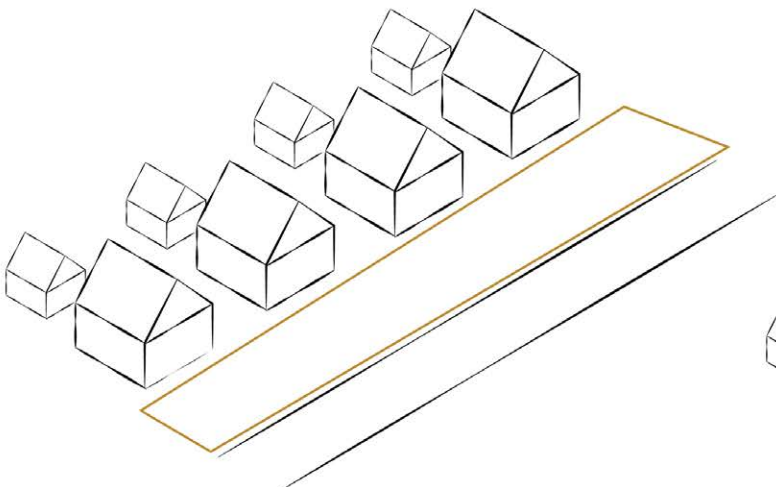

**Above:** Maintaining a consistent setback helps new construction to fit into the streetscape.

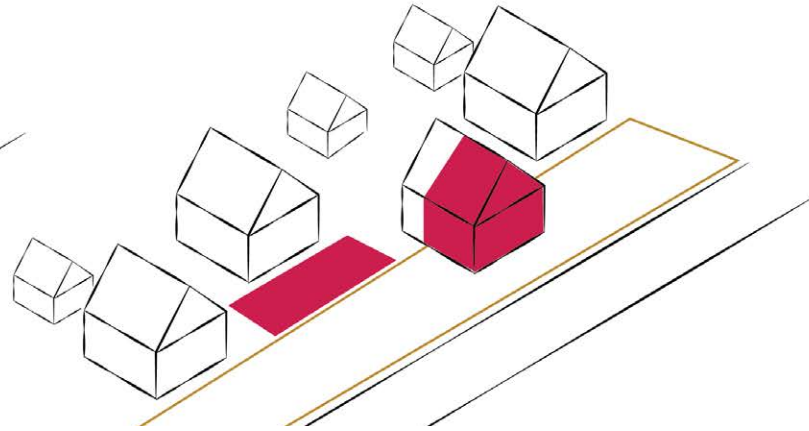

**Above:** Setbacks can be relatively small in older neighborhoods or larger in mid-century neighborhoods.



**Below:** Smaller multi-family buildings like these proposed duplexes can be designed with a location, scale, and massing that help them fit into the neighborhood.



## 2 Orientation

---

### *Standards*

- 2.1 Orient a new building to be consistent with the predominant orientation of contributing buildings on the same block.
- 2.2 Orient a new building towards the primary street.
- 2.3 For detached garages, match the predominant garage orientation found on the block's contributing properties. Do not use front-loaded garages on blocks where rear or alley-loaded garages historically were present.

## 3 Scale, Massing, and Height

---

### *Standards*

- 3.1 Design the height of new buildings to respond to nearby contributing buildings and the dimensions of the lot.
- 3.2 Design the massing of new buildings to reflect the character of nearby contributing buildings. Simple massing is typically appropriate.
- 3.3 Use step-downs in building height, wall-plane offsets, and other variations in building massing to provide a visual transition when the height of new construction exceeds that of adjacent contributing buildings by more than one-half story.
- 3.4 Align foundation and floor-to-floor heights with adjacent contributing buildings.
- 3.5 When constructing a duplex or multi-family building, divide the building into modules that reflect typical widths of historic single-family dwellings on adjacent properties or the same block.
- 3.6 Design accessory buildings to be visually subordinate to the primary building in height, massing, and form, as viewed from the street.

### *Recommendation*

- Do not exceed the height of the tallest contributing building on the block.

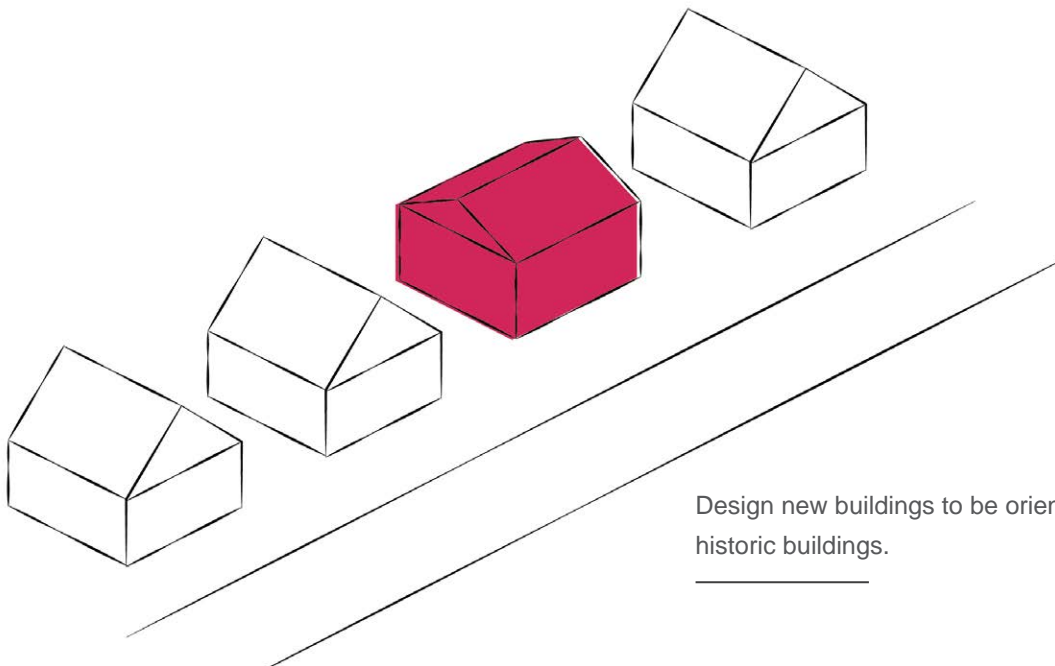

Design new buildings to be oriented like nearby historic buildings.

---

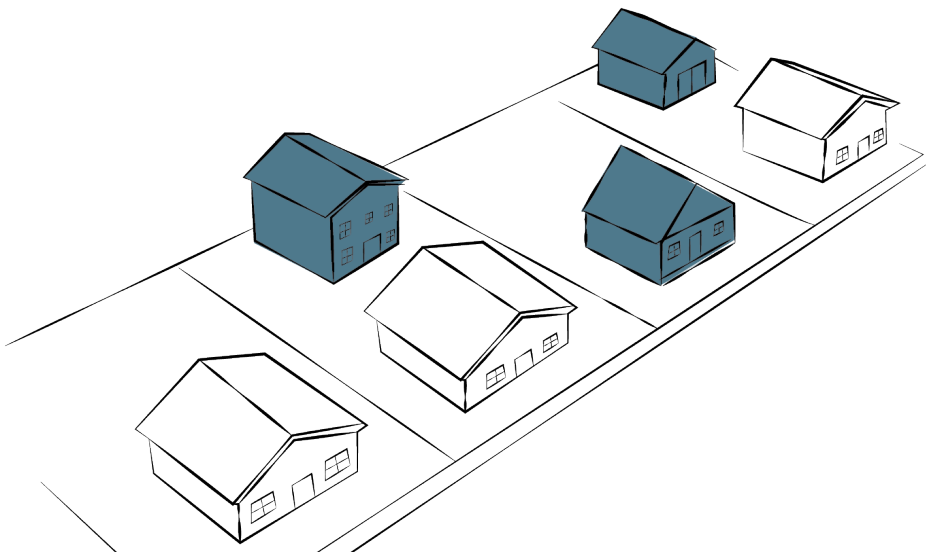

Massing and height of new buildings should be similar to nearby historic buildings.

---



New accessory buildings should take design cues from the principal building on the property, as well as nearby accessory buildings.

---

## 4 Proportions

A building's proportions speak to its overall orientation and appearance. For example, if most contributing buildings are long and low, with strong horizontal elements, reflect those horizontal proportions in new construction. There is more flexibility with the proportions of rear buildings, since they are set back from the street.

---

### *Standards*

- 4.1 Design the proportions of new buildings to be compatible with those of contributing buildings on the same block.
- 4.2 If the proportions of contributing buildings on a block vary, the design of a new building may select from those options.

## 5 Design and Style

To preserve the character of a historic landmark or historic district, a new building should take its design cues from nearby historic buildings and be visually distinguishable as new construction. New buildings do not need to mimic the architectural styles of the landmark or district, but they should not be so dissimilar as to distract from or diminish the historic character.

---

### *Standards*

- 5.1 Design new buildings to be compatible with the character of the primary building, historic district, and/or historic landmark in terms of scale, massing, proportions, patterns, materials, and architectural features.
- 5.2 Design new buildings to be differentiated from historic buildings. Do not use a replica style to create a false sense of history.
- 5.3 No particular architectural style is required. Designs in both traditional and modern styles can successfully achieve compatibility and differentiation with historic buildings.
- 5.4 If designing a building in a modern style, use corresponding modern architectural details.
- 5.5 Do not combine character-defining features from different architectural styles unless similar eclectic buildings were historically present in the historic district or on the historic landmark property.
- 5.6 Prefabricated outbuildings that are not in keeping with the historic character of the district are not allowed if they are visible from the street that the property faces.

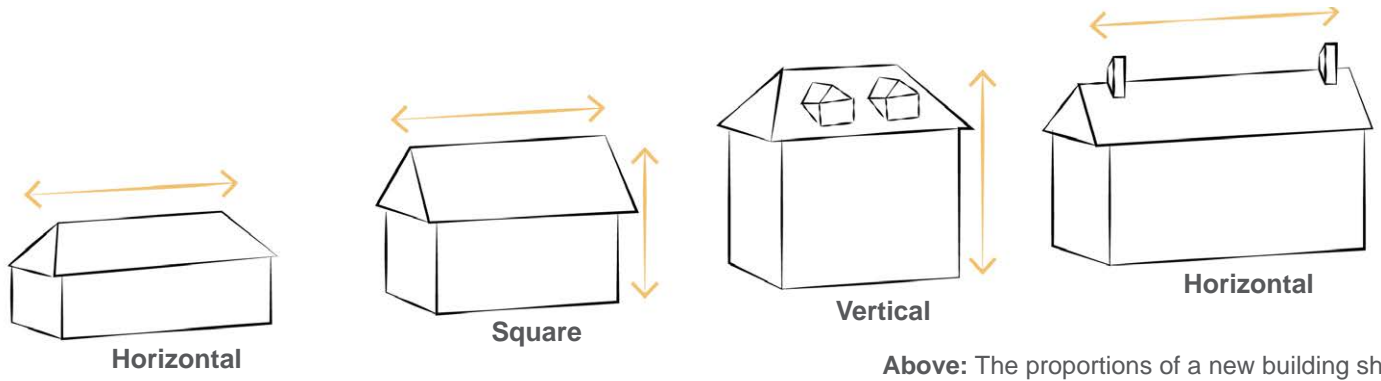

**Above:** The proportions of a new building should be similar to that of nearby contributing buildings.



New designs in historic districts can be traditional or contemporary.



## 6 Roofs

---

### Standards

- 6.1 Design simple roof forms that reflect the character of the roofs on contributing buildings.
- 6.2 Any roof details such as dormers, eave detailing, and bargeboards must correspond to the form and architectural style of the new building.
- 6.3 Select roof materials that match or are compatible with the roofs on contributing buildings, particularly buildings with a similar form and architectural style to the new building.
  - a. Metal roofs in a historic district may be appropriate, depending on the type of metal proposed.
  - b. If metal roofs historically were present in the district, construct new metal roofs with similar finish and details.

### Recommendation

- Where possible and practicable, locate solar panels on a rear-facing roof slope so that they are not visible from the street.

## 7 Exterior Walls

---

### Standards

- 7.1 Use exterior wall materials that are compatible with the character of the historic district in scale, type, material, size, finish, and texture.
- 7.2 For rear buildings, use siding that is compatible with the primary building.
- 7.3 Do not use vinyl or aluminum siding.
- 7.4 Make the use, pattern, and arrangement of secondary materials compatible with the character of the district.
- 7.5 Avoid windowless walls visible from a street, unless such walls are a character-defining feature of the historic district.

## 8 Windows and Doors

---

### Standards

- 8.1 Design street-facing facades to have similar window and door opening patterns as nearby contributing buildings.
- 8.2 Select windows that are compatible with nearby contributing buildings in terms of size, configuration, and profile.
- 8.3 For rear buildings, match the style, proportions, and materials of the windows to the primary building's style and design.
- 8.4 Locate front doors of new primary buildings so that they are visible from the street, unless another entrance location is a character-defining feature of the historic district.
- 8.5 Match the style, proportions, and materials of the front door to the building's style and design.

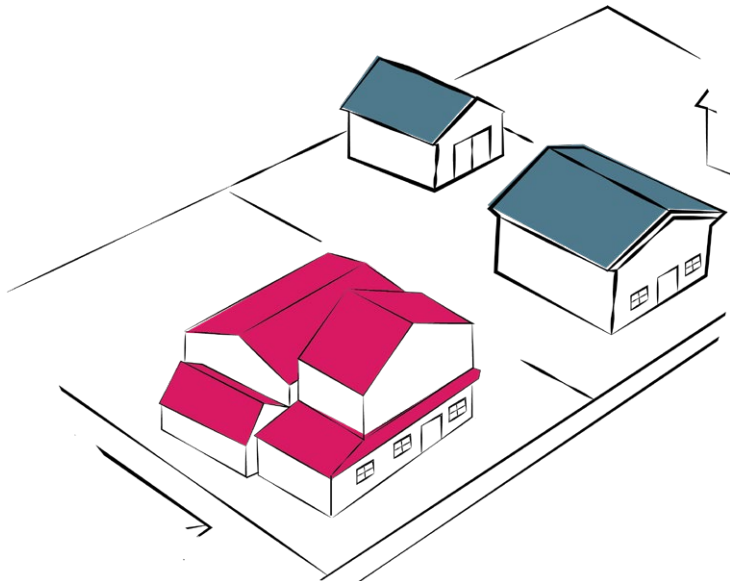

Simple roof forms fit in with historic buildings and help make new buildings good neighbors.

---

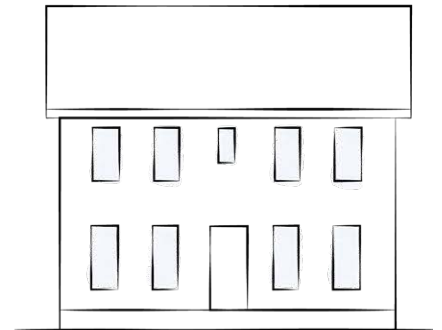
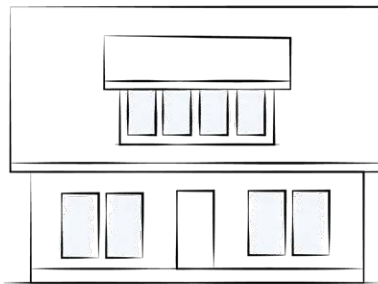
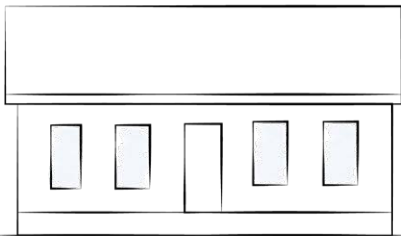

Look to nearby historic buildings for design cues: how window and door openings are arranged, as well as the proportions of the openings.

---

## 9 Porches

---

### *Standards*

- 9.1 Include a porch in the design of new primary buildings if the majority of contributing buildings on the same block have porches.
- 9.2 Design new porches that reflect and continue the size, proportions, placement, depth, and rhythm of porches on contributing buildings within the district.

- 9.3 Front porches are not required on rear buildings. If designing a porch on a rear building, it must be compatible with the building's style, proportions, and materials.

## 10 Chimneys

---

### *Standards*

- 10.1 Do not construct a box chimney.

## 11 Attached Garages and Carports

---

### *Standards*

- 11.1 In historic districts, construct a new attached garage at the front only if it matches the predominant garage location and orientation found on the block's contributing properties and is appropriate to the building's form and style.
- 11.2 Set attached garages and carports back from the front wall of the building to minimize their visual prominence.





**Above:** Porches help new residential buildings to fit into the rhythm of a historic streetscape.

**Below:** Garages and carports should fit in with the character of the historic district. In most districts, this means that a substantial setback will be necessary.

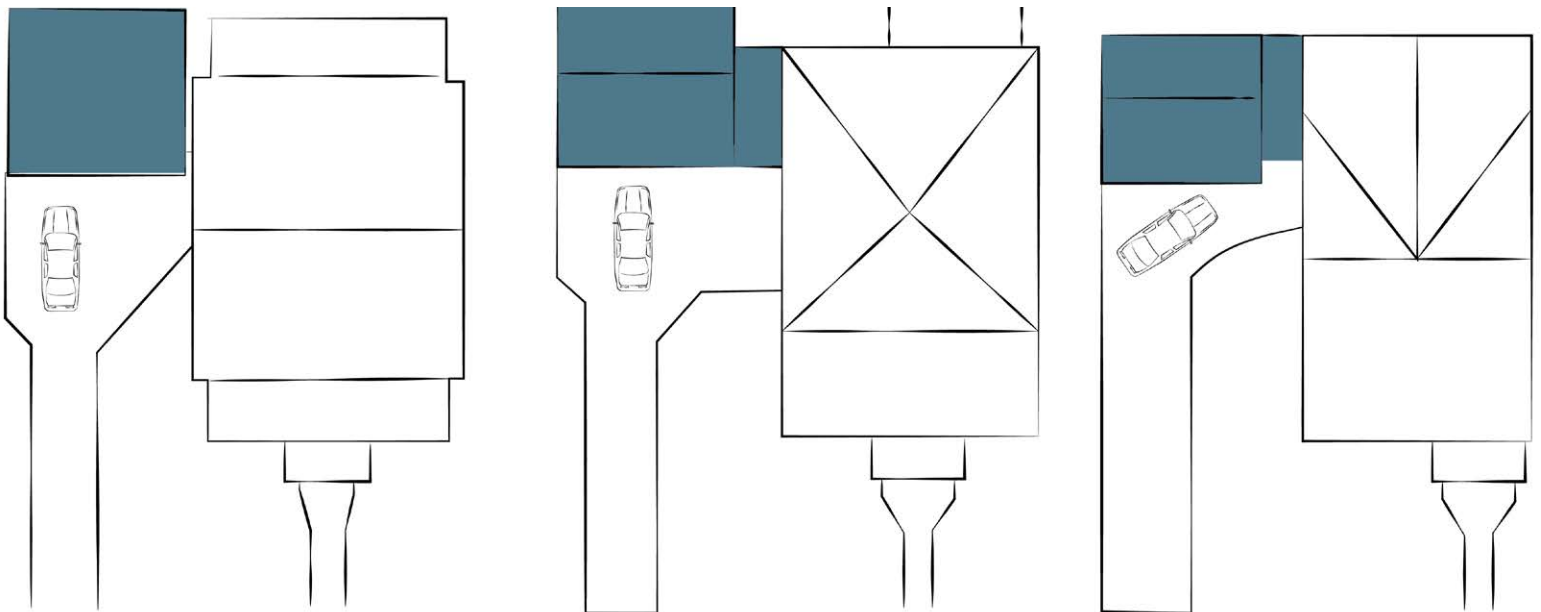

# Commercial Additions

Location 71

Scale, massing, and height 71

Design and style 73

Roofs 73

Materials 73

Balconies 75

Rooftop patios 75

 Meets sustainability goals

## When the standards apply to commercial additions

Three types of historic properties are regulated through the City of Austin historic review process.

*Do they need to follow these design standards?*

Historic landmarks	✓
Historic districts	✓ Contributing properties ~ Noncontributing properties—recommended, not required
National Register districts	~ Recommended, not required

---

Austin's historic commercial buildings are typically small-scale, whether they are located downtown, along commercial corridors, or in neighborhood centers. Precisely because they are modest, they tell an important story of Austin's provincial beginnings, steady growth as the state capital and seat of the University of Texas, and explosive changes after World War II and into the 21<sup>st</sup> century.

At the same time, central business district zoning and focused development pressures mean that new skyscrapers stand shoulder to shoulder with two- and three-story historic buildings downtown and in some historic districts. Though typical preservation standards limit commercial additions to a single story, these design standards acknowledge the disparity between Austin's low-rise historic buildings and skyrocketing development pressures. Consequently, the standards provide guidance for sensitive additions to expand usable space *and* preserve the important asset of the historic building, while recognizing that high-rise additions will not be appropriate for every historic building, particularly historic landmarks.

This chapter provides standards for additions to historic commercial buildings. Alterations to the historic building itself, including storefronts, awnings, and canopies, are addressed in the **Repair and Alterations** chapter.

# 1 Location

An addition should preserve the character of the historic building and site. Visual subordination to and compatibility with the historic building can be achieved through location, scale, massing, design, and materials.

## Standards

- 1.1 Locate additions at the rear and sides of historic buildings to minimize visual impact.
- 1.2 Set back additions from the front wall at a distance that preserves the perceived massing of the historic building, considering the pedestrian view from the opposite side of the primary street.
  - a. Additions must be set back at least 20' from the front wall of the historic building.
- 1.3 Minimize the loss of historic fabric by connecting additions to the existing building through the most noninvasive location and methods.
- ★ *Additional standard for historic landmarks*
- 1.4 Additions are not appropriate for all historic landmarks and will be evaluated on a case-by-case basis.

# 2 Scale, Massing, and Height

## Standards

- 2.1 Design the addition to complement the scale and massing of the historic building.
- 2.2 Design the addition to appear subordinate to the historic building.
- 2.3 Minimize the appearance of the addition from the primary street(s). The historic building's overall shape as viewed from the opposite side of the primary street must appear relatively unaltered.
- 2.4 Additions are subject to a 20' setback. They may be cantilevered 5' towards the front wall, but may not extend closer than 15' behind the front wall. The cantilevered portion must begin above the historic building's roof:
  - a. At least 2 times the height of the historic building, for buildings that are one or two stories high.
  - b. At least 1 time the height of the historic building, for buildings that are more than two stories high.
- 2.5 Match floor-to-floor heights as closely as possible with an adjacent historic building, if extant.

## Recommendations

- Design one-story additions to one-story buildings.
- Construct a large addition as a separate building and connect it to the historic building with a linking element such as a breezeway or a hyphen.

## Other regulations

- Buildings in the Sixth/Pecan Street overlay district may not exceed 45' in height. See regulations for the Sixth/Pecan Street (PS) overlay district for more information.
- Buildings in the Congress Avenue combining district must be at least 30' high and no taller than 90' high. This applies to new buildings within 60' of the west side of Congress Avenue and within 40' of the east side of Congress Avenue. See regulations for the Congress Avenue (CA) combining district for more information.

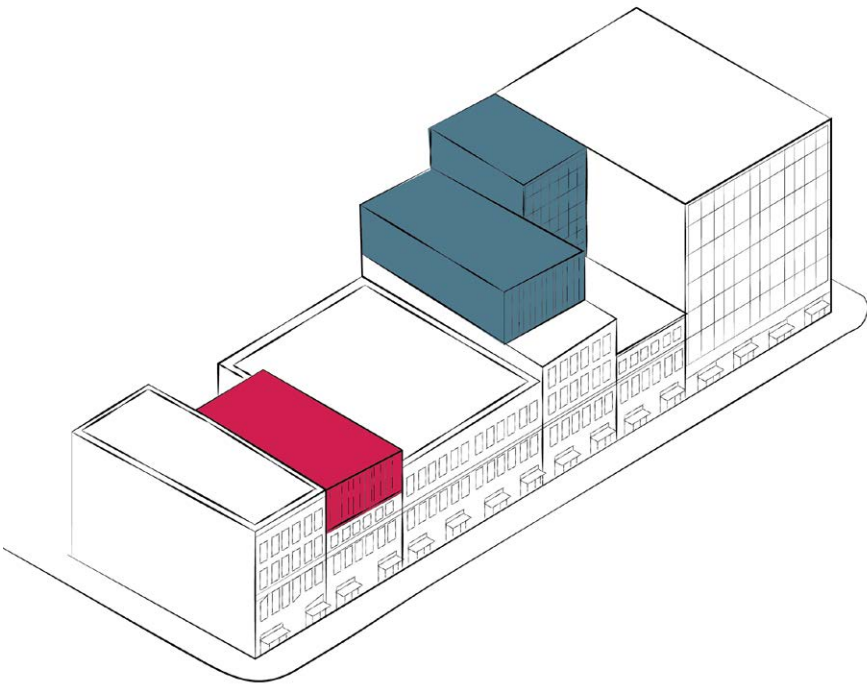

Set back additions from the front wall of the historic building at least 20' to preserve the appearance of the existing massing. The addition in red does not meet this standard.

---

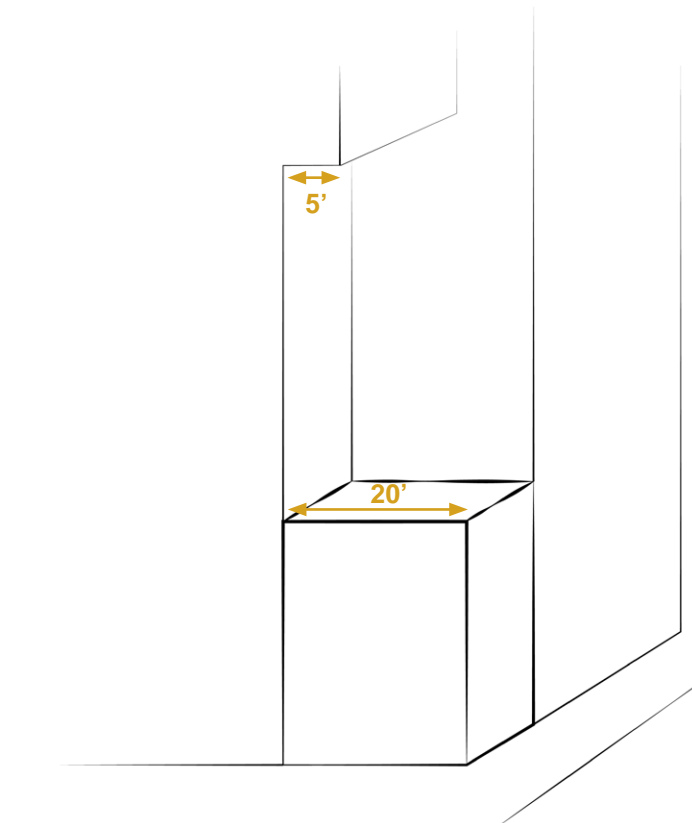

Standard 2.4 provides minimum requirements for cantilevered additions. An addition must respond to, prioritize, and be subordinate to the historic building, even if that means greater setbacks and vertical spacing.

---

**Resources:**

- [New Additions to Mid-Size Historic Buildings](#) (Interpreting the Standards 18), National Park Service
- [Rooftop Additions on Mid-Size Buildings](#) (Interpreting the Standards 47), National Park Service

## 3

## Design and Style

---

### Standards

- 3.1 Design proportions and patterns such as window-to-wall area ratios, floor-to-floor heights, fenestration patterns, and bay divisions to be compatible with the historic building.
- 3.2 Take cues for design elements and patterns from the historic building.
- 3.3 Do not replicate the design or details of the existing building to a degree that the addition might be mistaken as historic.
- 3.4 No particular architectural style is required for addition design. Designs in both traditional and

contemporary styles can successfully achieve compatibility and differentiation with historic buildings.

- 3.5 The historic primary entrance must remain the most prominent.
- 3.6 If windows on an addition will be visible from a primary street, use windows that are compatible with those on the historic building in terms of fenestration pattern, size, configuration, and profile.

## 4

## Roofs

---

These standards apply if the roof will be visible from the pedestrian level at the opposite side of the primary street.

### Standards

- 4.1 Design the roof form and slope of the addition to complement the roof on the historic building.
- 4.2 Use roof materials that match or are compatible with the roof on the historic building.

- 4.3 Minimize the visibility of the roof.

## 5

## Materials

---

### Standards

- 5.1 If an addition will be visible from the pedestrian level, including from the opposite side of the primary street, use exterior wall, window, and door materials that are compatible with those on the historic building in scale, proportion, material, finish, and texture.

- 5.2 Glass on the first floor must be transparent.

### Recommendation



- Use salvaged materials when possible.



This addition has compatible proportions with the historic building and reflects character-defining elements like simple massing, brick cladding, vertical window proportions, and regularly spaced, uniformly sized window openings.

---



**Above:** This addition would need to be set back farther under these standards, but its design highlights the historic building's strong vertical divisions, has a subordinate presence from the pedestrian level, and fits in with the height of nearby historic buildings.

---

**Left:** Additions to low- and mid-rise commercial buildings can be designed in a range of styles.

---

## 6 Balconies

---

### Standards

- 6.1 Do not add balconies to the front of a historic building unless physical, photographic, or plan evidence exists that they existed historically. If reconstructing balconies, replace them based on documentation of the historic feature.
- 6.2 Design new balconies on secondary elevations or additions to be compatible with both the historic building and the addition in terms of size, style, materials, and proportions.

## 7 Rooftop Patios

These standards apply to rooftop shade structures, railings, lighting, mechanical equipment, and plantings.

---

### Standards

- 7.1 Design and locate rooftop patio structures to be subordinate to the historic building; minimize visibility from the street.
- 7.2 Design rooftop patio structures to be compatible with the historic building in terms of design, size, style, materials, and proportions.
- 7.3 Design rooftop patio structures to be differentiated from the historic building, so that it does not appear they are part of historic-age construction.
- 7.4 Set back rooftop patio structures, railings, lighting, and mechanical equipment from the front wall a distance equal to 15' or half the width of the front wall, whichever is greater.
- 7.5 Use a visually light railing that does not distract from the historic building.

7.6 Install rooftop patio structures so that they can be removed without permanent damage to the historic building.

7.7 Keep rooftop plantings low so that they are not visible over the parapet from the opposite side of the street.

 *Additional standards for historic landmarks*

7.8 Do not add a permanent rooftop patio structure to a historic landmark. Temporary structures may be approved for a length of time to be determined by the Historic Landmark Commission.



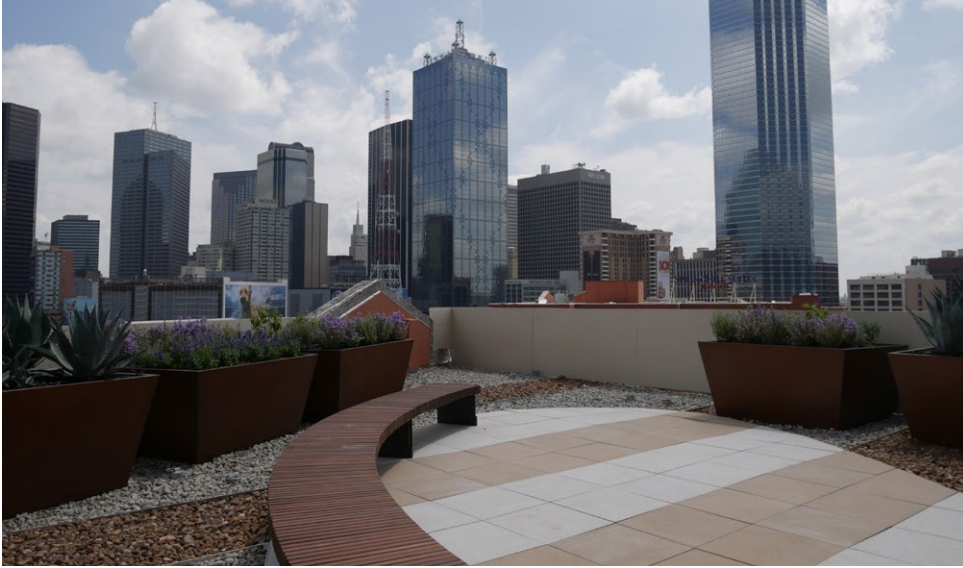

Rooftop plantings should not be visible over the parapet.

---



Setting back seating areas from the front wall minimizes visibility and is also safer.

---

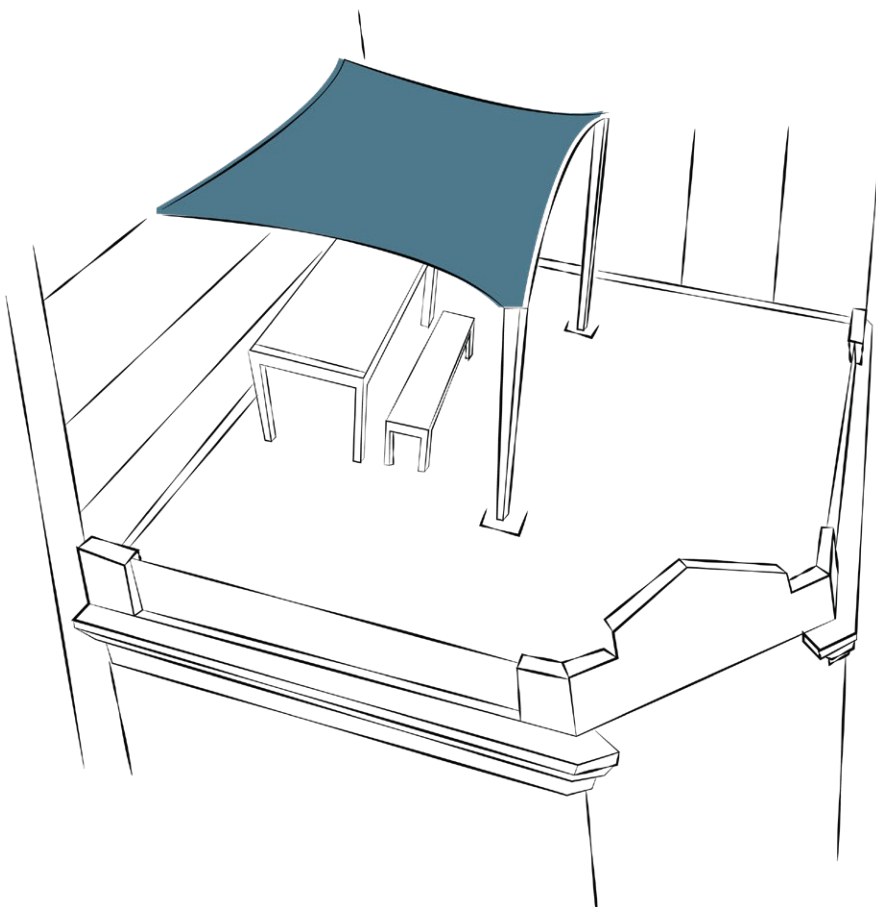

Setbacks help keep rooftop patio structures from looming over a building.

---

# Commercial New Construction

Location 79

Scale, massing, and height 79

Design and style 81

Materials 81

Storefronts 81

Parking structures 81

## When the standards apply to commercial new construction

Three types of historic properties are regulated through the City of Austin historic review process.

*Do they need to follow these design standards?*

Historic landmarks	✓	
Historic districts	✓	Contributing properties
	✓	Noncontributing properties
National Register districts	~	Recommended, not required

---

New construction next to historic buildings—which are typically smaller-scale—responds to the market context and heights allowed by zoning, but it should also respond to historic district character and prioritize the pedestrian experience.

# 1 Location

---

## Standards

- 1.1 Set back a new building from the street:
  - a. In line with at least one adjacent historic building; or
  - b. The median setback of all historic buildings on the same blockface.
- 1.2 Locate a new building to maintain the rhythm of contributing buildings on the street.
- 1.3 Orient a new building to be consistent with the predominant orientation of contributing buildings on the same block.

# 2 Scale, Massing, and Height

---

## Standards

- 2.1 Design the massing of new buildings to reflect the massing of nearby historic buildings. Simple massing is typically appropriate.
- 2.2 Match floor-to-floor heights as closely as possible with at least one adjacent historic building, if extant.
- 2.3 Visually divide wider buildings into vertical bays that reflect typical widths of historic buildings on adjacent properties or the same block.
- 2.4 For wider and taller buildings, make the lower floors (the base of the building) equal to the height of the adjacent historic building. Use vertical and horizontal articulation design techniques such as shifts in wall planes and differentiating materials to reduce a building's apparent scale and massing.
- 2.5 In low-rise commercial districts, use step-downs in building height, wall-plane offsets, and other variations in building massing to provide a visual transition when the height of new construction exceeds that of adjacent contributing buildings by more than one story.

## Other regulations

- New buildings in the Sixth/Pecan Street overlay district may not exceed 45' in height. See regulations for the Sixth/Pecan Street (PS) overlay district for more information.
- New buildings in the Congress Avenue combining district must be at least 30' high and no taller than 90' high. This applies to new buildings within 60' of the west side of Congress Avenue and within 40' of the east side of Congress Avenue. See regulations for the Congress Avenue (CA) combining district for more information.

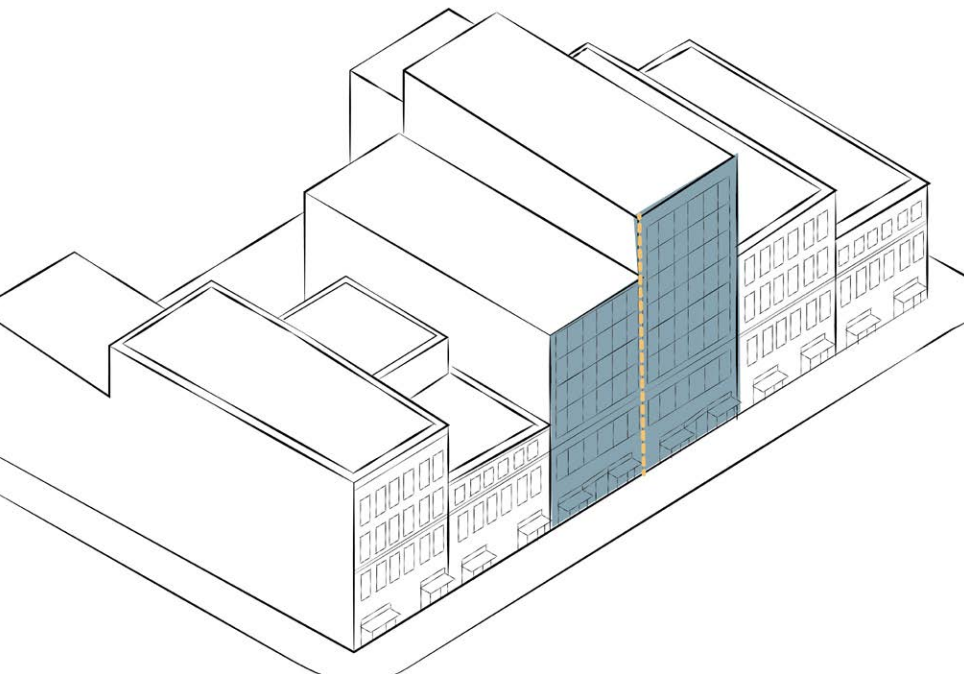

Designing wider new buildings to have visual vertical divisions helps them to fit in with the historic streetscape.

---



Taller new buildings can respond to historic buildings by including compatible design elements such as storefronts, window patterns and proportions, and intermediate cornices on lower floors.

---



Design new buildings with floor-to-floor heights that match at least one neighboring historic building as closely as possible.

---

## 3 Design and Style

---

### Standards

- 3.1 Design new buildings to be compatible with the character of the historic district and/or historic landmark in terms of proportions, patterns, materials, and architectural features.
- 3.2 Design new buildings to be differentiated from historic buildings. Do not use a replica style to create a false sense of history.
- 3.3 No particular architectural style is required.

## 4 Materials

---

### Standards

- 4.1 Use building materials that are compatible with the historic district and the style of the building.
- 4.2 Use materials to visually divide larger buildings into modules that reflect typical widths of historic buildings on adjacent properties or the same block.
- 4.3 Glass on the first floor must be transparent.

## 5 Storefronts

---

### Standards

- 5.1 Prioritize the pedestrian experience at the base of commercial buildings (lower floors) through large windows, prominent entrances, and pedestrian-scale detailing.
- 5.2 Design storefronts to be a similar width to storefronts on nearby historic buildings.

## 6 Parking Structures

---

### Standards

- 6.1 Prioritize the pedestrian experience at the street level.
  - a. If possible, design the building to include ground-floor storefronts facing the street.
  - b. If storefronts are not possible, provide visual interest through other means such as architectural detailing, public art, and/or landscaping.
- 6.2 Design the parking structure to be compatible with the massing and scale of nearby buildings, using the design standards in this chapter.
- 6.3 Screen the upper stories using architectural screens or other design elements.



This building features a traditional design and materials at the base, with a modern design and materials above.

---



This building's angular design and curtain wall construction are very modern, but its height, curtain wall pattern, and wide pedestrian entrance refer to nearby historic buildings.

---

# Institutional Buildings

General standards 85

## When the standards apply to institutional buildings

Three types of historic properties are regulated through the City of Austin historic review process.

*Do they need to follow these design standards?*

---

Historic landmarks



---

Historic districts



Contributing properties



Noncontributing properties—recommended, not required unless stand-alone new construction is involved

---

National Register districts



Recommended, not required



---

Community and civic institutions play an essential role in shaping Austin and its citizens. The buildings that house these institutions—churches and other religious organizations, government agencies, and schools—speak clearly to historic significance. They are often, but not always, stand-alone buildings that are more monumental than the houses and stores around them. If the people funding construction had the means, buildings were built to last, like the institutions they housed.

This short chapter includes brief considerations that are unique to institutional buildings. Consult the **Repair and Alterations** chapter for information on maintenance and alterations to the building envelope. For changes or additions to the shape of a building, see the **Commercial Additions** chapter. The **Residential Additions** chapter may be applicable if the building is modestly scaled.

# 1 General Standards

When considering changes to historic institutional buildings, consult Historic Preservation Office staff early in the planning process.

---

## *Standards*

- 1.1 Ensure that the building's historic character is preserved through careful repair and maintenance of historic materials.
- 1.2 Additions to an institutional building may not be appropriate.
- 1.3 Locate additions to be subordinate to the historic building, keeping in mind that all sides of an institutional building may be significant.



Institutional buildings speak to community values and resources.

---



Institutional buildings are typically the most prominent on the block.

---

**Resources:**

- [Rehabilitation and Adaptive Reuse of Schools](#) (Interpreting the Standards 12), National Park Service
- [Converting Historic School Buildings for Residential Use](#) (Interpreting the Standards 20), National Park Service

# Sites and Streetscapes

Vegetation, topography, and landscaping 89

Walls and fences 89

Mechanical equipment and site appurtenances 91

Accessibility 91

Sidewalks, driveways, and parking 93

Streetscape elements 93

 Meets sustainability goals

## When the standards apply to sites and streetscapes

Three types of historic properties are regulated through the City of Austin historic review process.

*Do they need to follow these design standards?*

Historic landmarks	✓
Historic districts	✓ Contributing properties ~ Noncontributing properties—recommended, not required
National Register districts	~ Recommended, not required

---

Site and streetscape elements help to define the character of a historic landmark and, on a larger scale, a historic district. Site walls, walkways, and driveways speak to the development patterns and societal values of the period when buildings were built, while details such as formal gateways and mosaic street signs add local character to an area. Their retention and preservation helps keep historic character intact.

Refer to the Character-defining Features section of the application for your historic district to learn which site features should be preserved.

# 1 Vegetation, Topography, and Landscaping

## Standards

- 1.1 Do not grade, fill, or excavate unless it is to solve a drainage or flooding problem.
- 1.2 Retain permanent landscape features that define the character of the property and the district. Protect them when constructing new buildings or additions.

## ★ Additional standard for historic landmarks

- 1.3 If the property had a grassy, open front lawn when constructed, maintain that context. Do not replace the lawn with paving or gravel.

## Recommendations

- Select vegetation that allows the front of the historic building to be seen from the street.
- Use landscaping to screen a new building, rear addition, or deck at the back and side property lines.
- Avoid planting trees or shrubs too close to a building to prevent issues with maintenance.
- Design and maintain sprinkler systems to avoid water spraying on the building and prevent uneven moisture around the foundation.

# 2 Walls and Fences

## Standards

- ☀ 2.1 Retain historic fences and site walls on the street side or sides of the property, including gates and hardware.
- 2.2 Repair historic street-side fences and site walls with matching design and materials.
- ☀ 2.3 If damage or deterioration requires replacement of a portion of a street-side fence or site wall, replace only that portion in-kind, matching the design, materials, size, and finish.
- 2.4 If constructing a new street-side fence or site wall, design it so that the materials, style, and scale are compatible with and differentiated from the architectural style and period of the building and are in keeping with historic fence styles and heights in the historic district.
  - a. New front fences must be no more than 4' high and have a high degree of transparency.

## ★ Additional standard for historic landmarks

- 2.5 Do not paint or cover over historic masonry site walls.

## Recommendations

- If a street-side fence or site wall was not historically present and is not part of the historic development pattern of the district, do not construct one.
- If reconstructing a historic street-side fence, base it on documentation of the historic feature.
- When repairing character-defining fences and site walls, use historic material from a less prominent location to repair a prominent location.





Features like site walls, open spaces, and public infrastructure contribute to the character of historic properties and districts.

---





## 3 Mechanical Equipment and Site Appurtenances

### Standards

-  3.1 Locate mechanical and energy conservation equipment and rainwater collection systems where they will not obscure or intrude upon the primary view of the building.
- 3.2 Attach electrical and mechanical equipment to exterior walls using methods that do not damage the historic wall material.
  - a. If the walls are masonry, anchor attachments into the mortar, not the masonry unit.
- 3.3 Do not damage historic building features or materials during installation.
-  3.4 Locate wind power systems at the rear of the property.

### Recommendations

-  • As much as possible, use solar power and solar thermal systems that are in scale with the existing roofline of the building and on the same plane as the roof.
-  • As much as possible, locate solar power and solar thermal systems, antennae, and satellite dishes on accessory buildings, new additions, and primary building rooftops not visible from the street.
-  • For wind turbines, choose a muted color without graphics.
- As much as possible, locate site appurtenances like wires, utility poles and meters, and trash containers in inconspicuous areas to the rear or side of the building, not in the front. Screen them with plantings.
- As much as possible, bury utilities underground.

## 4 Accessibility

### Standards

- 4.1 Avoid significant alterations to building design and materials while complying with accessibility requirements. Do not modify historic entrances on the front wall of a building in a way that destroys or diminishes the architectural character of the entrance unless no reasonable alternative is available.
- 4.2 Design ramps, lifts, and handrails to be unobtrusive and to complement the historic character of the building through design and materials.
- 4.3 Design ramps and lifts so that they can be removed in the future without damage to the

building. Wood ramps are recommended for houses.

### Recommendations

- Incorporate minor changes in grade to modify sidewalk or walkway elevations to provide ADA-compliant entries.
- When possible, avoid lifts in favor of ramps so that people with disabilities can access the building without assistance.



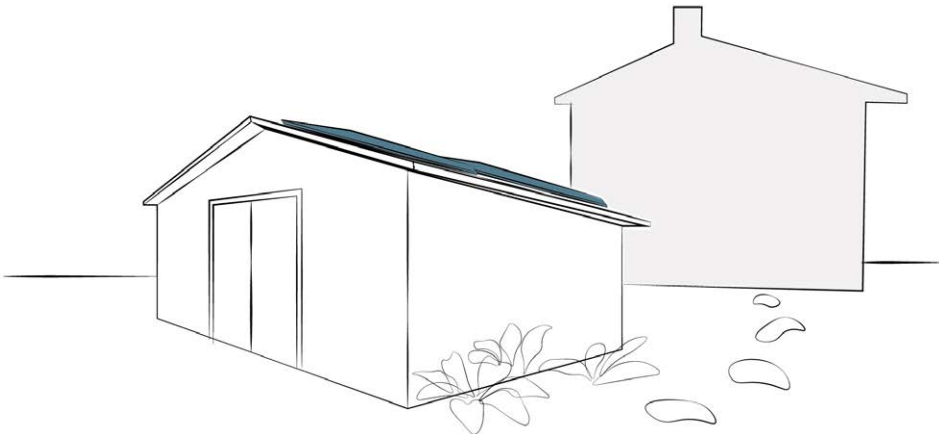

Locate solar power systems on accessory buildings where possible.

---

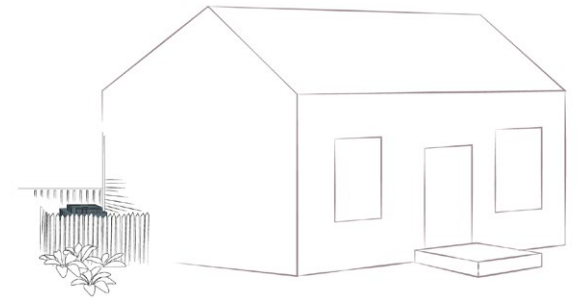

Locate mechanical units where they will not block the primary view of the building.

---



Wood ramps are recommended when needed to provide access to houses.

---



Ramps should not detract from the historic character of a building.

---

Resources:

- [Making Historic Properties Accessible](#) (Preservation Brief 32), National Park Service
- [Providing Access to Historic Properties](#), Texas Historical Commission



## 5 Sidewalks, Driveways, and Parking

These standards apply to sidewalks, driveways, and off-street parking areas located on properties.

### Standards

- 5.1 Repair historic sidewalks, driveways, and parking areas with a matching design and materials.
- 5.2 Construct new sidewalks and driveways that are compatible with the character of the district in location, size, width, pattern, and material.
- 5.3 Do not locate a parking area in front of a primary building unless one was present historically. Locating a parking area to the side of the primary building is acceptable if a rear location is not feasible.
- 5.4 Parking requirements may be reduced or waived if new curb cuts and driveways are not compatible with the historic development patterns of the property or district.

### Recommendations

-  • Retain historic sidewalks, driveways, and parking areas.
-  • If damage or deterioration requires replacement of walkways, driveways, or parking areas, replace only the damaged portion. If full replacement is necessary, use a design and materials that match the historic feature.
- If reconstructing a historic walkway or driveway, replace it based on historic documentation.
-  • Construct driveways and parking areas with environmentally friendly materials and configurations for lower impervious cover.

## 6 Streetscape Elements

These standards apply to streets, sidewalks, parking strips, curbs, alleys, and streetscape elements in the public right-of-way and should be followed by City departments and property owners as applicable.

### Standards

- 6.1 Retain character-defining public infrastructure such as streets, sidewalks, bridges, planting strips, curbs, gutters, and alleys.
- 6.2 Retain character-defining streetscape elements such as historic gateway entrances, mosaic curb signs, lights, and street furniture.
- 6.3 Construct new streets, sidewalks, planting strips, curbs, ADA ramps, and alleys to be compatible with the style, scale, materials, and configuration of the historic district.
- 6.4 Install street lighting that is compatible with the design, materials, and scale of the historic district. If historic light fixtures exist, design new lighting to match their design, materials, and scale.

- 6.5 Do not introduce new materials or features to create a false sense of history.
- 6.6 Do not block pedestrian-level views of historic buildings with streetscape elements.
- 6.7 Constructing new sidewalks is encouraged, even if they were not historically present.

### Recommendations

-  • Retain as much historic material as possible when repairing streets, sidewalks, and alleys.
- If replacement is necessary, use materials that match or are compatible with historic materials.
- Add plantings that are compatible with the character of the district in species, mature height, and density.



Sidewalks, driveways, and streetscape elements are character-defining features.

---



Historic gateways and markers announce entryways to neighborhoods.

---



Retain and repair historic bridges, sidewalks, curbs, and steps with matching materials.

---



Permeable driveways are encouraged.

---

**Resources:**

- [Streetscape Guidelines for Historic Commercial Districts](#), Texas Historical Commission

# Demolition and Relocation

Standards 97

Demolition by neglect 97

 Meets sustainability goals

## When the standards apply to demolition and relocation

Three types of historic properties are regulated through the City of Austin historic review process.

*Do they need to follow these design standards?*

Historic landmarks	✓
Historic districts	✓ Contributing properties
	~ Noncontributing properties—recommended, not required
National Register districts	~ Recommended, not required

---

Historic buildings are irreplaceable community assets. Once they are gone, they are gone forever. The loss of even one building creates a noticeable gap and erodes the character of a historic district. Therefore, the demolition or relocation of any historic building is rarely approved.

The Historic Landmark Commission may consider relocation within the same district as an exception, if it retains a building's historic context.



# 1 Demolition and Relocation

---

## Standards

-  1.1 Do not demolish or relocate a historic building.
- 1.2 If demolition or relocation is necessary, ensure the safety of the building and any adjacent properties before, during, and afterwards.

## Recommendations

-  • Work with the Historic Preservation Office and Historic Landmark Commission to pursue all alternatives to demolition or relocation.
-  • If demolition is approved, work with the Historic Preservation Office and other interested parties to salvage usable architectural materials and features.

-  • If demolition is approved, review the City of Austin's Construction and Demolition Recycling program to learn about how to divert waste from the landfill.

## Note

If demolition or relocation is approved, the Historic Landmark Commission may require submission of a City of Austin Documentation Package consisting of photographs of all elevations, a dimensioned sketch plan, and a narrative history, for archiving at the Austin History Center.

# 2 Demolition by Neglect

---

Demolition by neglect is inaction that results in the destruction or irredeemable deterioration of a building. The owner of a historic property is required by the Land Development Code to preserve the property against decay and deterioration. If the stability of the historic resource is compromised due to the owner's neglect, the owner may be subject to fines and other penalties.

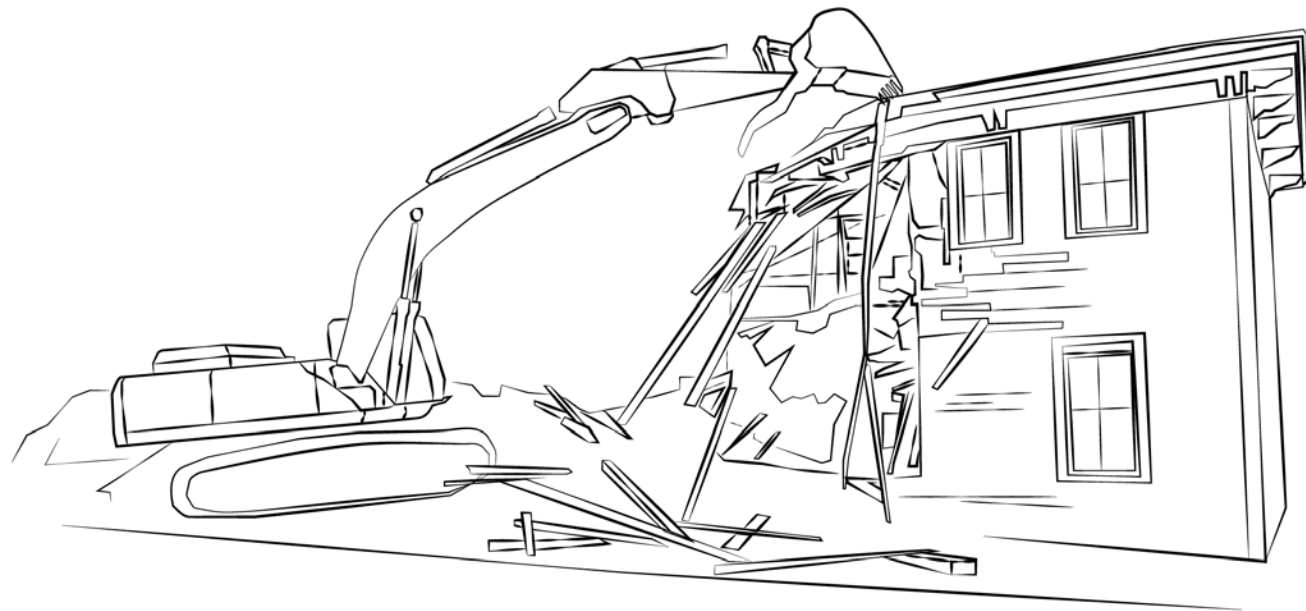

Demolishing a historic building leaves a noticeable gap in a historic streetscape.

---



# Maintenance and Preservation of Historic Materials

---

Wood 101

Masonry 102

Stucco 103

Metal 103

Paint 104

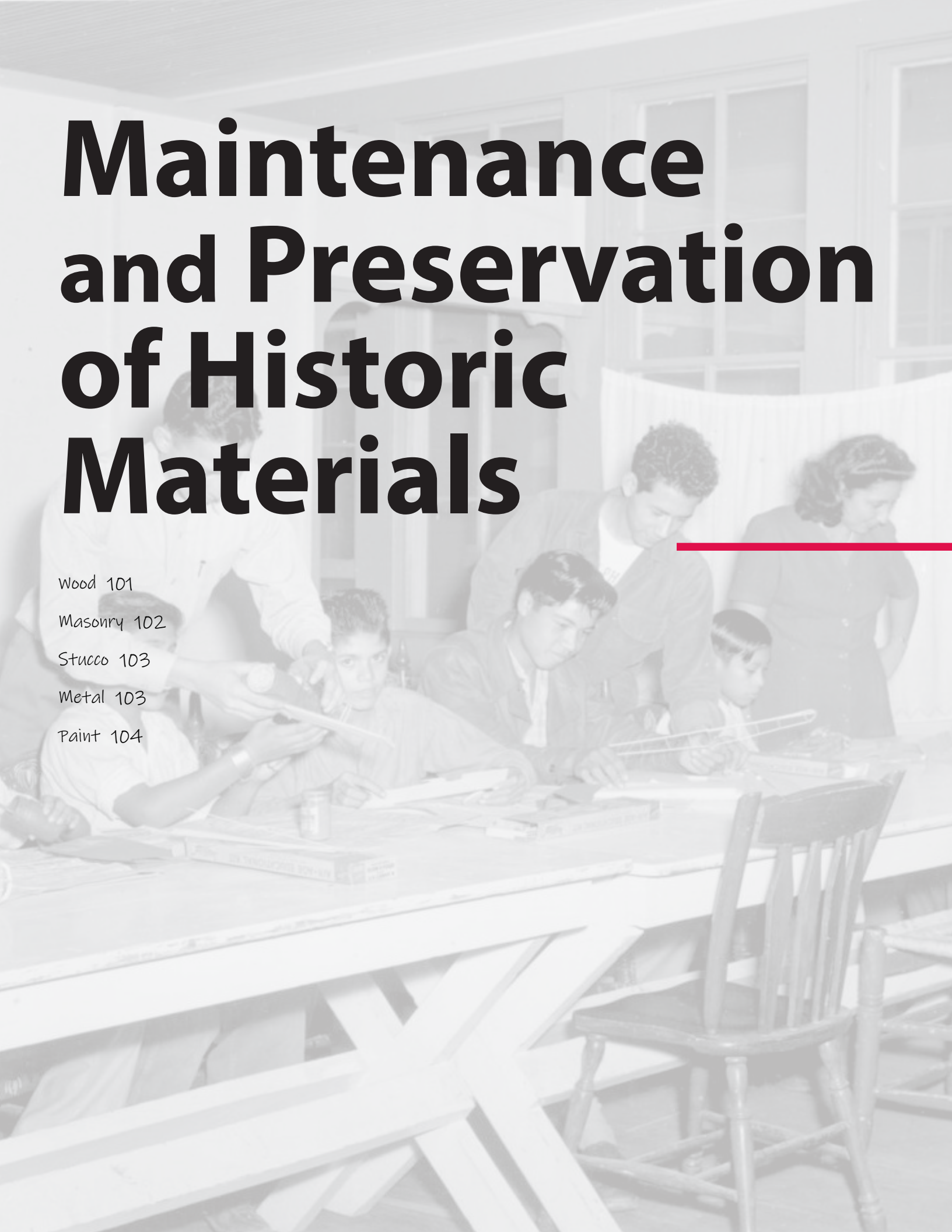



---

These standards encourage proactive maintenance against issues like ultraviolet radiation, wood-destroying insects, and moisture from rain, poor drainage, or leaks. This chapter offers basic background on common building materials, maintenance recommendations, and additional resources for each.

## Wood

---

As an affordable, workable, light material that could be shipped easily, wood was historically popular as a building material in Austin. In the 19<sup>th</sup> and early 20<sup>th</sup> centuries, wood was typically milled from old-growth forests. The grain pattern of this wood is very tight because the trees grew slowly, adding relatively little thickness from year to year. That denser grain means that old-growth wood is more durable than today's wood, which is harvested from trees selected for their rapid growth. New wood has wide growth rings that result in a softer, more porous material.

Well-maintained paint can extend the lifetime of wood. Proper drainage off a roof and around the perimeter of a building will keep the wood dry.

Luckily, wood is easily workable, and replacement pieces can be fabricated to replace deteriorated portions. Using old-growth wood from older buildings ensures that the patch will age as well as the surrounding historic material. Rot-resistant species such as cypress or mahogany can also be used for small repairs. Treated materials should be chosen carefully.

### *Recommendations*

These recommendations supplement the standards and recommendations for specific building elements.

- Identify and address underlying water issues, if present, to ensure the longevity of any repair.
- When historic material rots and requires replacement, cut back to solid wood and patch parts of members with compatible material with a similar density, grain, and texture; replace whole members only when necessary.
- An exact matching material like old-growth wood is preferable, but other rot-resistant materials of similar density can be considered. Exceptions will be addressed on a case-by-case basis.

### *Additional Resources*

- [The Repair of Historic Wooden Windows](#) (Preservation Brief 9), National Park Service
- [Window Preservation Standards](#), Window Preservation Standards Collaborative
- [Holding the Line: Controlling Unwanted Moisture in Historic Buildings](#) (Preservation Brief 39), National Park Service
- [Preserving Historic Wooden Porches](#) (Preservation Brief 45), National Park Service
- [Exterior Paint Problems on Historic Woodwork](#) (Preservation Brief 10), National Park Service
- [Preservation Tech Notes on exterior wood](#), National Park Service

# Masonry

---

Masonry can serve as load-bearing construction, where multiple wythes or layers make up the wall itself, or as veneer construction, where it is the exterior face of a wood-frame structural wall. Whether load-bearing or veneer, masonry is connected by mortar between each masonry unit. The mortar must be softer than the stone or brick. Masonry walls are designed to move, either with minor foundation shifting or with the expansion and contraction of the masonry in extreme hot or cold weather. The exterior of a mortar joint will degrade over time with exposure to sun, wind, rain, and movement.

Owners of masonry buildings should plan to replace the mortar occasionally through repointing. In this process, mortar is removed to a given depth between the stone units, leaving enough material to support the wall. Replacement mortar that matches the historic mortar in strength, composition, joint profile, and color is then inserted. Choose an experienced stonemason, consult with a preservation professional, and obtain historic approval before undertaking this important activity.

Multiple factors should be considered in planning and executing a repointing project to avoid damage to the historic stone or brick. Remove existing mortar by hand to avoid cutting or chipping the masonry. Take care to select the proper mortar: Hard mortars, particularly those with high Portland cement content, can result in irreparable damage to masonry.

Masonry cleaning must also be planned and executed with care to avoid damage. Sandblasting or other media blasting, high-pressure water, or harsh chemicals can cause irreversible harm to historic masonry. As with repointing, consult with a preservation professional and choose a contractor with experience in cleaning similar historic materials. Test products and techniques in an inconspicuous area, and allow the test patch to weather before proceeding.

All masonry will absorb some moisture from the atmosphere and the ground and is designed to release the moisture as conditions dry. For this reason, exterior masonry should not be painted—this will hold in the moisture and might prevent the wall from drying. If replacing paint on a masonry wall that was historically painted, strip the existing coats of paint before adding new coats, and select paint carefully. Masonry materials typically leach alkalinity and require coating systems specifically designed for the application.

## *Recommendations*

These recommendations supplement the standards and recommendations for specific building elements.

- Repair broken masonry units before replacing them.
- When replacement is required due to erosion or deterioration, either replace whole members or cut back to solid stone and patch parts of members with compatible material of a similar density and hardness.
- When repointing, choose an appropriate mortar that is softer than the masonry unit.
- Avoid harsh cleaning methods.

## *Additional Resources*

- [Assessing Cleaning and Water-repellent Treatments for Historic Masonry Buildings](#) (Preservation Brief 1), National Park Service
- [Repointing Mortar Joints in Historic Masonry Buildings](#) (Preservation Brief 2), National Park Service
- [Holding the Line: Controlling Unwanted Moisture in Historic Buildings](#) (Preservation Brief 39), National Park Service
- [Preservation of Historic Concrete](#) (Preservation Brief 15), National Park Service
- [Preservation Tech Notes on masonry](#), National Park Service

## Stucco

---

Stucco is a form of exterior plastering that can be laid over wood or metal lath or a masonry backing wall. It is less common in Austin, which makes it all the more important as a historic element when it does exist here. Like masonry, stucco moves with the heat and cold of the day and throughout the year and must be carefully detailed to survive this movement while staying attached to its substrate. Repair, rather than replace, an intact stucco wall. If full replacement is required, consider the historic installation and the unique conditions of the building, and plan change carefully. Stucco walls typically require control joints to manage their expansion and contraction.

### *Recommendations*

These recommendations supplement the standards and recommendations for specific building elements.

- Repair, rather than replace, historic material. This includes both patching cracks and, for patches of damage, removing loose or deteriorated stucco while retaining sound material and patching the damaged area only with material matching in color, texture, and composition with the historic material.
- When replacement is required due to complete failure, replace it with material that has a similar composition, texture, and finish.

### *Additional Resources*

- [The Preservation and Repair of Historic Stucco](#) (Preservation Brief 39), National Park Service

## Metal

---

Metals can be found in many historic buildings, as far back as the 19<sup>th</sup> century. Cast iron was often used for detailing in the Victorian era, and wrought iron was often used structurally and decoratively for fences and railings. Metal is also commonly found in post-World War II buildings, when mining and manufacturing facilities designed to contribute to the war effort were converted for civilian use. Metal window systems are typical for mid-20<sup>th</sup> century buildings. Mid-century modern design often used metal frames for its characteristic expansive windows.

Metal treatment can vary widely based on the materials. Cast and wrought iron will rust quickly if not properly coated. Aluminum does not rust, but it does oxidize. Not easily painted, it typically requires specially formulated chemical painting systems. Patinas on exterior bronze as well as aluminum form a protective coating and can be beneficial. Owners should consider carefully before refinishing metals.

### *Recommendation*

This recommendation supplements the standards and recommendations for specific building elements.

- When replacement is required due to complete failure, replace it with compatible material with a similar composition.

### *Additional Resources*

- [The Repair and Thermal Upgrading of Historic Steel Windows](#) (Preservation Brief 13), National Park Service
- [The Maintenance and Repair of Architectural Cast Iron](#) (Preservation Brief 27), National Park Service
- [Restoring Metal Roof Cornices](#) (Preservation Tech Notes—Metals No. 2), National Park Service

# Paint

---

Owners of wood buildings should repaint their exteriors on a regular basis. It is typically not advised to paint masonry. Painting metal requires proper preparation of the substrate.

Qualified painters should be prepared to work with lead-based paint, which was used extensively prior to the 1970s. Use a qualified contractor who is committed to protecting workers and the surrounding environment in accordance with local, state, and federal regulations. The preferred method is to remove and properly dispose of lead paint with a liquid or sheet stripper, allowing modern paint systems to adhere to the base material without sanding or encapsulation.

Paint colors are reviewed for historic landmarks, but not for other historic properties.

## *Recommendations*

These recommendations supplement the standards and recommendations for specific building elements.

- Select a durable paint product appropriate for the material being painted.
- If masonry has been painted outside of the historic period, consider removing the paint using methods that do not damage the masonry.

## *Additional Resources*

- [Exterior Paint Problems on Historic Woodwork](#) (Preservation Brief 10), National Park Service
- [Appropriate Methods for Reducing Lead-paint Hazards in Historic Housing](#) (Preservation Brief 37), National Park Service



# Glossary

*General terms* 107

*Architectural terms*

*Building parts* 109

*Foundations* 110

*Roof* 111

*Wall and roof materials* 113

*Windows* 115

*Storefronts* 117

*Ornamentation* 118

*Other terms* 120

*Index of terms* 123

---

The following glossary provides definitions for common preservation and architectural terms. If additional information is needed, consult the following resources:

- *Illustrated Dictionary of Historic Architecture*, edited by Cyril M. Harris
- *A Field Guide to American Houses: The Definitive Guide to Identifying and Understanding America's Domestic Architecture, Second Edition*, by Virginia Savage McAlester
- *Old House Dictionary*, by Steven J. Phillips
- *Dictionary of Building Architecture*, by Ward Bucher, AIA
- *A Visual Dictionary of Architecture*, by Francis D. K. Ching

## General Terms

Definition sources include the City of Austin Land Development Code, the National Park Service, and Galveston's Historic Design Guidelines.

---

### Accessory building

A building or building(s) which can help to convey a site's overall history but is less critical in conveying the historic significance of the site than the primary building.

### Addition

Any structure physically attached to the primary building; including finished and unfinished space, interior and exterior (porch/deck) spaces.

### Alteration

Any exterior change, demolition, or modification to a historic landmark or to a contributing property located in a historic district (HD), including, but not limited to:

- Exterior changes to or modifications of structures, architectural details, or visual characteristics;
- Construction of new structures;
- Disturbance of archaeological sites or areas; or
- Placement or removal of exterior objects that affect the exterior qualities of the property.

### Architectural fabric

Physical building or decorative components from a structure's original construction or period of significance.

### Architectural style

A classification typically based on the exterior attributes of the structure. A building may have influences from multiple styles.

### Character-defining feature

An architectural element, which alone or as part of a pattern, embodies the style, design, or general arrangement of the exterior of a building or structure, including but not limited to the kind, color, and texture of building materials, and style and type of windows, doors, lights, porches, and signs.

### Compatible

Existing or performing in harmonious, agreeable combination with its surroundings.

### Context

The setting in which a historic element, site, structure, street or district exists.

### Contributing property

A building, structure, or object that contributes to the historic character of the historic district. The district application includes an inventory and maps listing all contributing properties.

### Demolition

Any act or process that destroys or razes in whole, or in part, a building, object, site or structure, including the permanent impairment of structural integrity. This includes demolition by neglect, which is defined as inaction or series of inactions that result in the destruction or irredeemable deterioration of a landmark building.

### Historic building

A structure significant in local, state or national history, architecture, engineering, archaeology, or culture.

### In-kind repair

Repairs using the same material, with the same design and profile, to repair or replace a small area of deteriorated or damaged historic materials.

### Integrity

The authenticity of a property's historic identity evidenced by the survival of physical characteristics.

### Massing

The physical size and bulk of a structure. A building's massing is derived from the articulation of its façade through the use of dormers, towers, bays, porches, steps, and other projections. These projections significantly contribute to the character of the building and, in town, the character of a street.



## GLOSSARY

### Noncontributing property

A building, structure, or object that does not contribute to the character of a historic district. The district application includes an inventory and maps listing all noncontributing resources.

### Outbuilding

Accessory buildings such as garages or sheds.

### Period of significance

The span of time during which a historic resource or district was associated with the events that give it significance. In a historic district, this period can extend from the initial date of development to the date when buildings have been constructed on the majority of lots or to the date when construction slowed.

### Preservation

The act or process of applying measures necessary to sustain the existing form, integrity, and materials of an historic property. Work, including preliminary measures to protect and stabilize the property, generally focuses upon the ongoing maintenance and repair of historic materials and features rather than extensive replacement and new construction. The limited and sensitive upgrading of mechanical, electrical, and plumbing systems and other code-required work to make properties functional is appropriate within a preservation project. New exterior additions are not within the scope of this treatment.

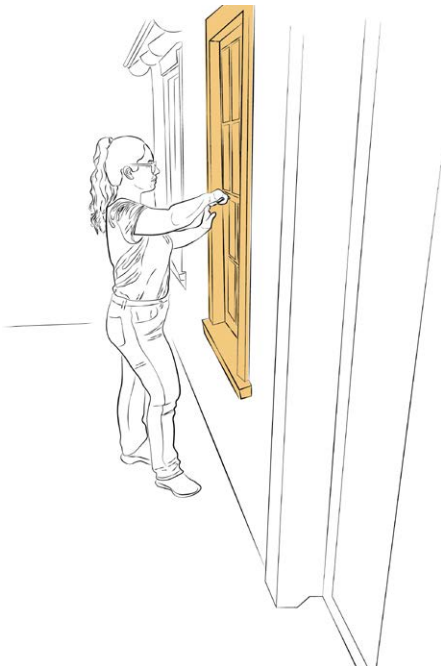

### Primary building

The building that contributes most to the historic significance of the overall site; typically the building closest to the street. Also called principal building.

### Reconstruction

The act or process of depicting, by means of new construction, the form, features, and detailing of a non-surviving site, landscape, building, structure, or object for the purpose of replicating its appearance at a specific period of time and in its historic location.

### Rehabilitation

The act or process of making possible a compatible use for a property through repair, alterations, and additions while preserving those portions or features which convey its historical, cultural, or architectural values.

### Restoration

The act or process of accurately depicting the form, features, and character of a property as it appeared at a particular period of time by means of the removal of features from other periods in its history and reconstruction of missing features from the restoration period.

### Rhythm

A pattern of change along a district or block influenced by architectural elements that divide the facades into intervals and maintain a pedestrian-friendly scale.

### Scale

The perceived size of a building relative to the size of its elements and to the size of elements in neighboring buildings. The overall shape and massing of buildings is significant to defining character. In order to retain the character of a community, maintaining a balance between landscaping and building scale in relation to space available is essential.

### Secondary building

See Accessory building and Outbuilding.

## Architectural Terms

Definition sources include the Secretary of the Interior's Standards and Treatment Guidelines, National Park Service Preservation Briefs, Britannica.com, Downtown Plano Design Standards, Lexico.com, *Merriam-Webster Dictionary*, *Old House Dictionary*, *Oxford Dictionary*, *Sense of Place: Design Guidelines for New Construction in Historic Districts*, Tatemono-Kenchiku Building Construction blog, *Twentieth-Century Building Materials*, *A Visual Dictionary of Architecture*, Wikipedia, and *Dictionary of Building Preservation*.

### Building parts

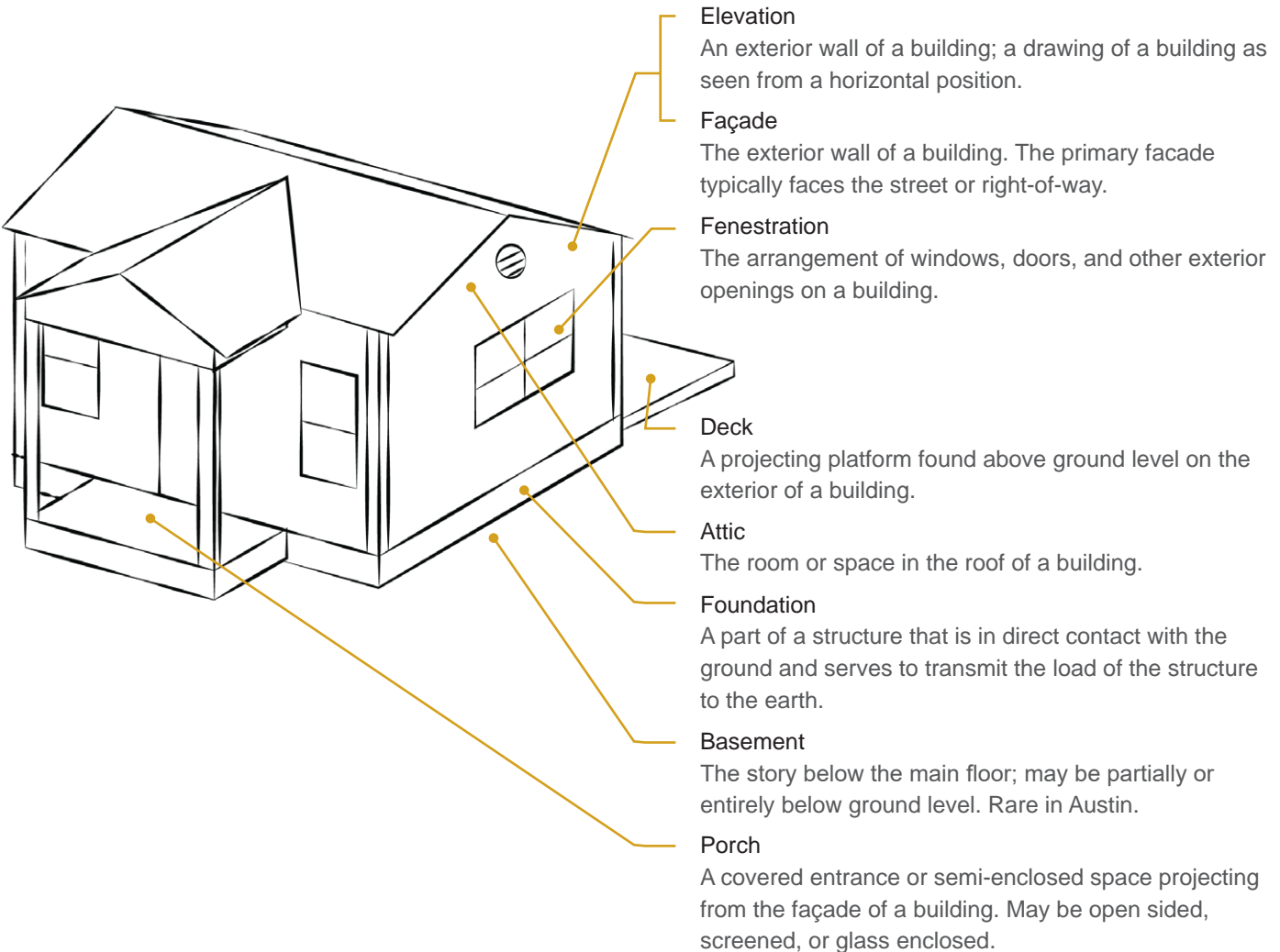

Foundations

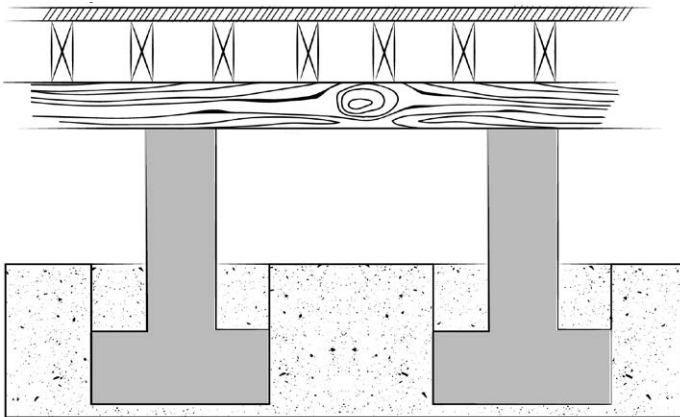

**Pier and beam foundation**

Foundation consisting of vertical piers set below grade, which support horizontal beams.

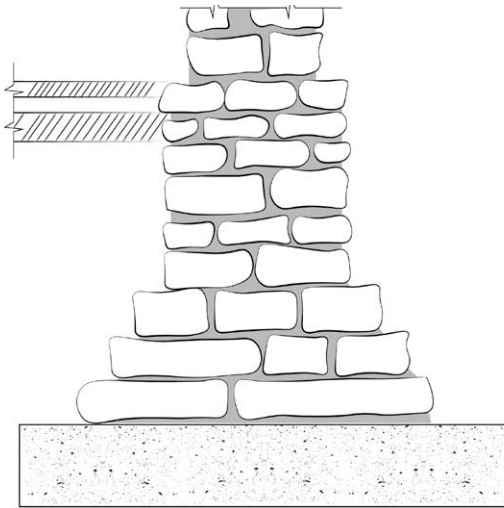

**Masonry foundation**

Foundation consisting of brick or stone masonry set below grade, which supports floor joists and a wall above.

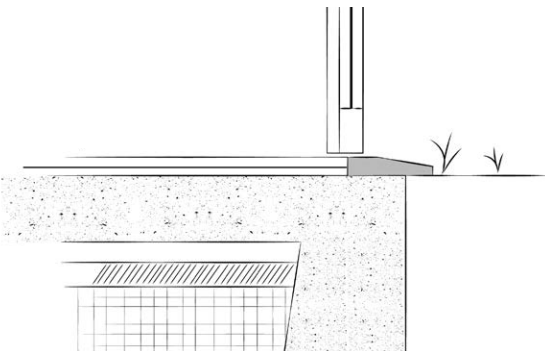

**Concrete slab foundation (slab-on-grade)**

Foundation consisting of a concrete floor slab that sits directly on the ground.



**Battered foundation**

A foundation that is built at an incline, so that it appears to slope inward as it rises.

Roof

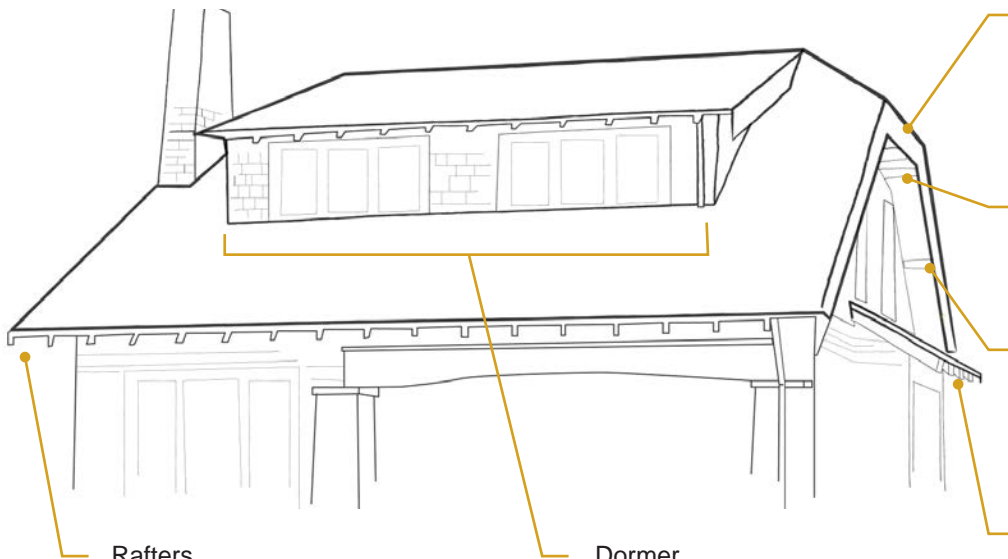

**Bargeboard**

A board, sometimes decorative, that adorns the gable end of a gabled roof; also called fascia boards.

**Soffit**

The underside of an overhanging element, such as the eaves of a roof.

**Bracket**

A projecting element under cornices, eaves, balconies, or windows to provide structural or visual support.

**Eaves**

The lower roof edge that projects past the building wall.

**Rafters**

The sloping members of a roof upon which the roof covering is placed.

**Rafter tails**

Visible rafter ends.

**Dormer**

A vertical window projecting from the slope of a roof; usually has its own roof.

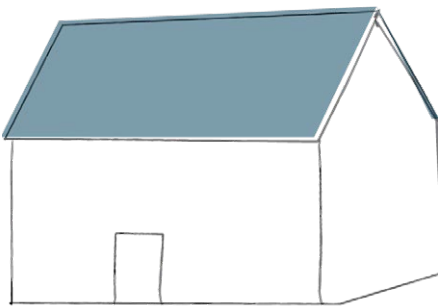

**Side-gabled roof**

A sloping (ridged) roof that terminates at one or both side ends in a gable; formed by two pitched roof surfaces.

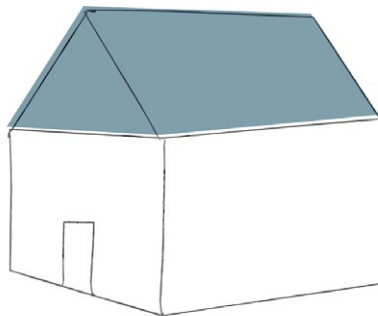

**Front-gabled roof**

A sloping (ridged) roof that terminates at the front end in a gable; formed by two pitched roof surfaces.

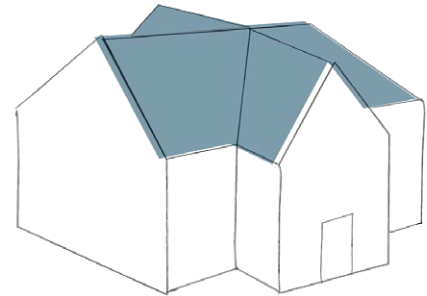

**Cross-gabled roof**

A gabled roof with ridges crossing in the middle.

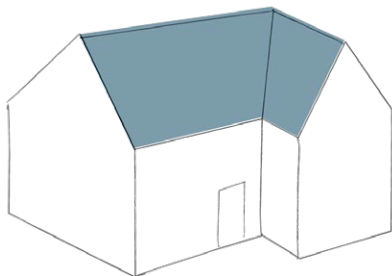

**Wing-and-gable roof**

A side-gabled roof with a front-gabled wing; ridges meet at one end.

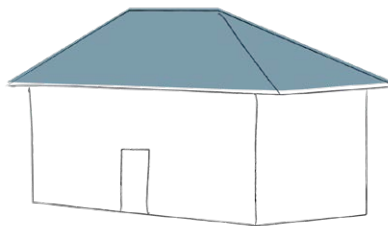

**Hipped roof**

A roof formed by four pitched roof surfaces.

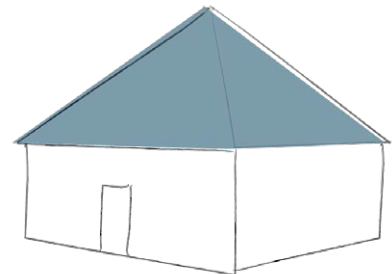

**Pyramidal roof**

A pyramid-shaped roof with four sides of equal slope and shape.

## GLOSSARY

### Boxed eaves

Eaves that are enclosed with a fascia and panels under the soffit.

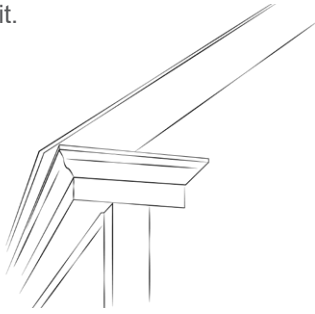

### Downspout

A pipe that carries water from the gutters to the ground or sewer connection.

### Eyebrow dormer

A low dormer with a curved roof that resembles the curve of an eyebrow.

### Fascia board

The flat area or board covering the ends of roof rafters or other flat areas.

### Gable end

The triangular upper part of a wall under the end of a ridged roof, or a wall rising above the end of a ridged roof.

### Gutter

A channel of wood or metal running along the eaves of the house, used for catching and carrying water.

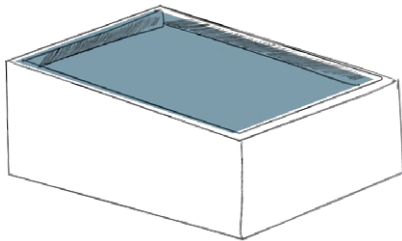
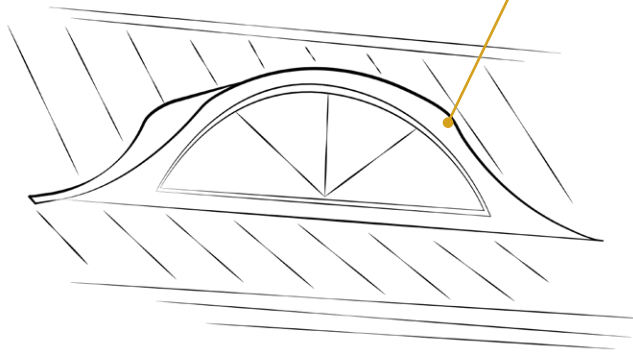

### Flat roof with parapet

A roof that has only enough pitch so that water can drain; edged by low parapet walls.

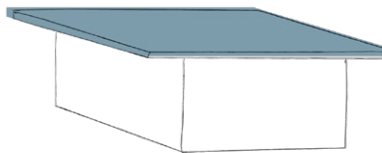

### Flat roof

A roof that has only enough pitch so that water can drain.

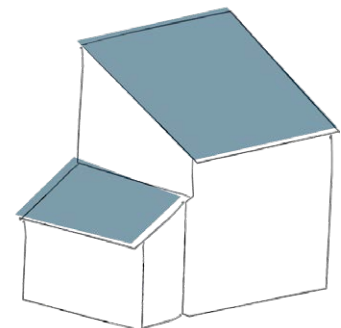

### Shed roof

A roof consisting of one sloping plane.

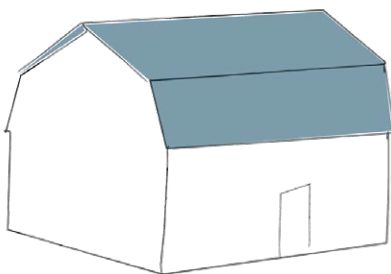

### Gambrel roof

A roof with a double slope on two sides of a building. The most common example is a barn roof.

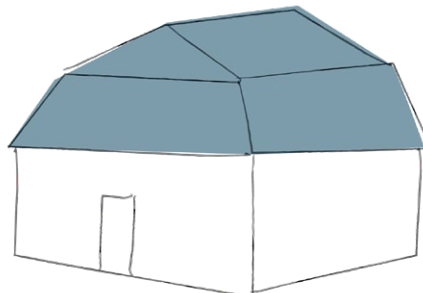

### Mansard roof

A roof with two slopes on all four sides; the lower slope is steeper than the upper.

## GLOSSARY

### Wall and roof materials



#### Aluminum siding

A metal exterior siding material, used for decoration and weatherproofing. Aluminum siding became a standard building material by the 1950s.



#### Asbestos siding

Cement reinforced with asbestos fibers; popular in the 20th century. Appears in shingle form, often with a wavy bottom edge, as well as longer strips of siding.



#### Board and batten

Wood siding with wide vertical boards and narrow strips of wood (battens) placed vertically to cover the seams; often used for accessory buildings and very simple houses.



#### Brick

A building or paving unit made of fired clay; usually rectangular-shaped.



#### Cast iron

An iron alloy with a high carbon content known for its strength in compression and fire resistance. Cast iron storefronts allowed for large ground-floor display windows in commercial properties.



#### Clapboard siding

A thin board, thinner at one edge than the other, laid horizontally and with edges overlapping.



#### Concrete

Composed of a mixture of sand, gravel, crushed stone, or other coarse material and bound together with lime or cement, concrete undergoes a chemical reaction and hardens when water is added. It has been used for utilitarian, ornamental, and monumental structures since ancient times.

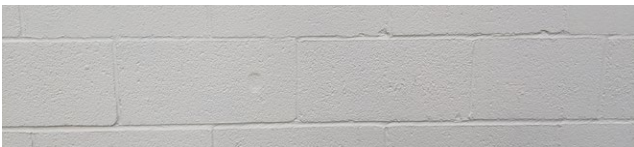

#### Concrete block

A hollow or solid rectangular block made of Portland cement, aggregates, and water; used to construct walls, foundations, and piers; also called a concrete masonry unit (CMU).



#### Corrugated metal

Sheets of metal with convex parallel ridges and valleys, often used for roofing in outbuildings and very simple houses.

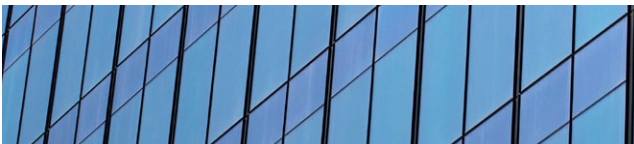

#### Curtain wall

An exterior wall hung or attached to the structural system of a building; typically constructed of glass, metal panels, thin stone veneer, or other materials.

## GLOSSARY

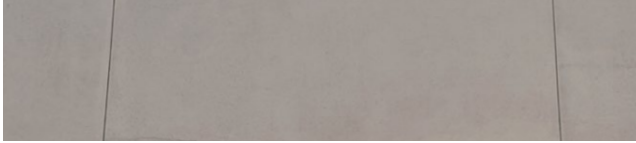

### EIFS

Exterior insulation and finish system that resembles stucco, popular in the 1980s–2000s.



### Fiber cement siding

A cladding material made of cement reinforced with cellulose fibers. Appears similar to wood, though may have a more pronounced regular “grain” and a shallower reveal for trim.



### Permastone

A cast stone veneer with individual units and mortared joints. In Austin, often used as a decorative cladding for the foundation.



### Rusticated stone

A type of decorative masonry achieved by cutting back the edges of stones to a plane surface while leaving the central portion of the face either rough or projecting markedly.

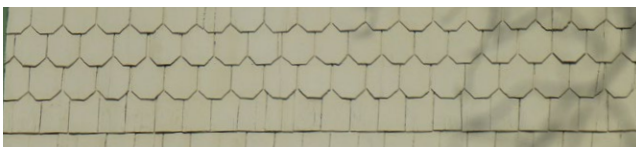

### Shingle

A small thin piece of building material often with one end thicker than the other for laying in overlapping rows as a covering for the roof or sides of a building.



### Shiplap siding

Wood siding with long ends that overlap the adjacent boards; may be flush or have a horizontal channel.



### Standing-seam metal

Roofing material with vertical folded seams joining flat panels.



### Stucco

An exterior finish material composed of Portland cement and/or lime and sand mixed with water.



### Tongue and groove

A joint composed of a rib (tongue) received by a groove, commonly seen in historic porch decking and wood flooring.



### Vinyl siding

A plastic exterior siding material, used for decoration and weatherproofing, imitating wood clapboard, board and batten or shakes. A narrow track outlines edges in the siding.

## GLOSSARY

### Windows



- Header, Lintel**  
The top horizontal member over a door or window opening.
- Jamb**  
An upright piece or surface forming the side of an opening (as for a door, window, or fireplace).
- Lite**  
Window pane.
- Muntin**  
A thin strip of wood used to separate and hold lites.
- Mullion**  
A large vertical member separating two casements or coupled windows or doors.
- Sill**  
Horizontal member at the bottom of a window or door opening.
- Apron**  
A plain or decorated piece of trim found directly below the sill of a window.

### Sash

The framework into which panels are set.

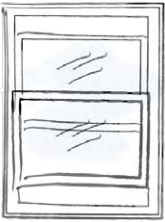

**Double-hung window**  
A window with upper and lower sashes that operate independently.



**Single-hung window**  
A window with an operable lower sash.

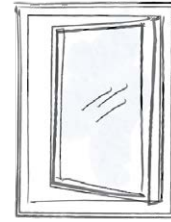

**Casement window**  
A hinged window that opens outward like a door.

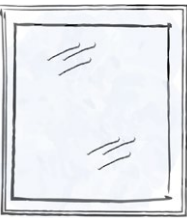

**Fixed sash**  
A window, or part of a window, that does not open.

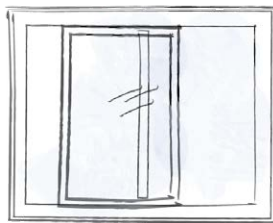

**Sliding window**  
A window with sashes that open horizontally on a track.

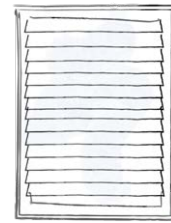

**Jalousie window**  
A window composed of angled, overlapping slats of glass, arranged horizontally like a shutter to tilt open.

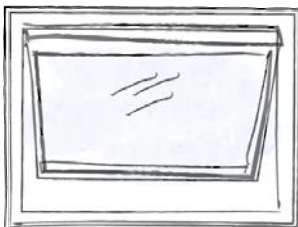

**Awning window**  
A window that is hinged at the top and swings outward.

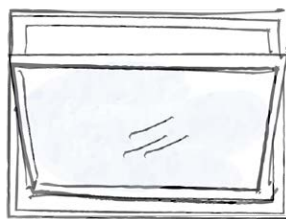

**Hopper window**  
A window that is hinged on the bottom and swings inward.



## GLOSSARY

### Bay window

A projecting window with an angular plan.

### Clerestory

Window in the upper portion of a wall toward the ceiling designed to admit light into the room.

### Fanlight

An arched window with muntins that radiate like a fan; typically used as a transom.

### Shutters

Solid blinds on either side of a window; may be plain or decorated, operative or purely ornamental.

### Side light

A vertical window flanking a door.

### Storm window

A secondary window installed to protect and/or reinforce the main window.

### Transom

A horizontal window over a door or window; see Storefronts section.



### Wood-sash window

Typically double-hung or fixed, with a deeper profile than other sash materials. Found in older buildings; can be repaired piece by piece.

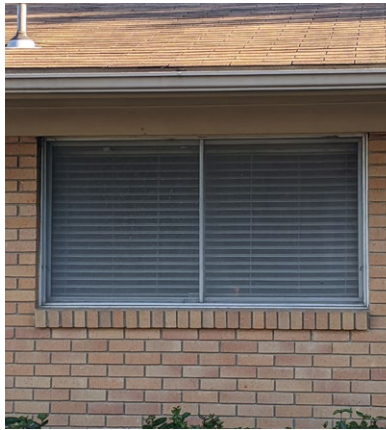

### Aluminum-sash window

Typically single-hung, casement, or sliding. Found as original windows in mid-century buildings or as replacements in older buildings.



### Steel-sash window

Typically casement or fixed, with multiple lites.



### Vinyl-sash window

Typically single-hung, casement, or fixed, with a flat profile. Inexpensive replacement for wood-sash windows, though with a shorter lifespan; cannot be repaired.



### Clad-wood window

Wood frame clad in aluminum frame; mimics the appearance of wood-sash windows but with sharper manufactured edges.



### Leaded glass window

A window composed of pieces of glass that are held in place with lead strips; the glass can be clear, colored, or stained.

## Storefronts

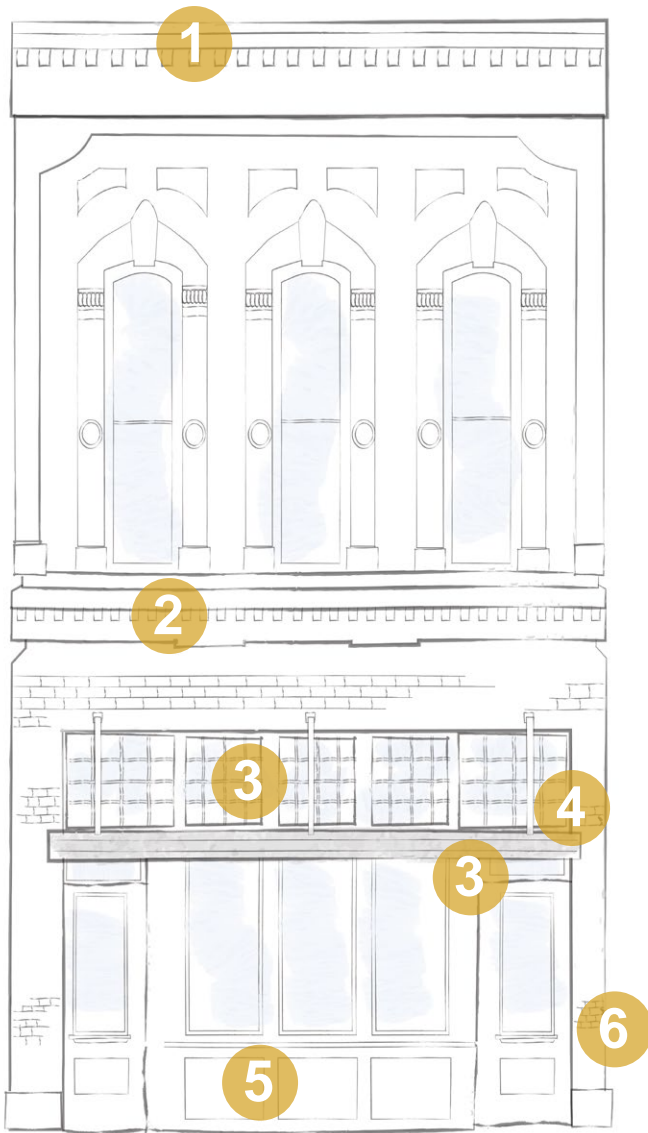

- 1** **Cornice**  
The projecting ornamental molding along the top of a building or a wall.
- 2** **Intermediate cornice**  
The projecting ornamental molding along the middle of a building or a wall, often above the ground or mezzanine level.
- 3** **Transom**  
A horizontal window over a door or window.
- 4** **Canopy**  
A rigid projection over a doorway or storefront that is supported by the building to which it is attached; may also be supported by freestanding posts or columns.
- 5** **Bulkhead**  
The portion of a storefront wall set below the display windows.
- 6** **Pier**  
A post or portion of a wall that supports a gate or door; in foundations, a post that carries the structure's weight to the foundation.

Storefront design and materials changed over time, but many of the same elements are present in storefronts from the late 1800s, early 1900s, and postwar period.

Ornamentation

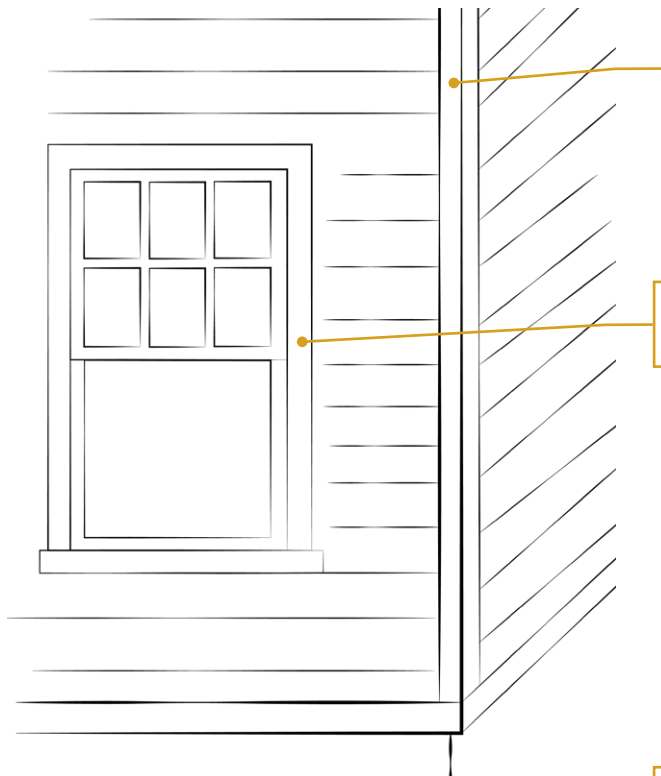

**Corner boards**

Boards placed at the corners of exterior walls to finish corners and to protect the ends of wood siding.

**Molding**

Decorative strip of wood used for ornamentation or finishing.

**Surround, Trim**

A border, element, or area around the edge of something, especially one that is decorated.

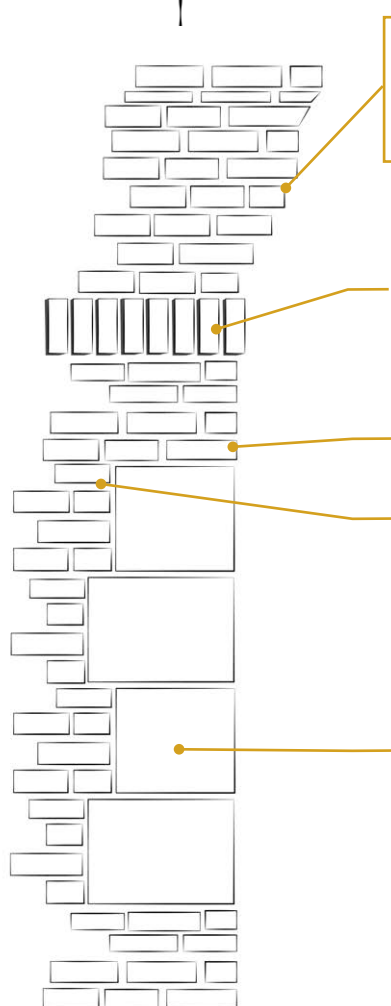

**Corbel**

A projecting block, sometimes carved or molded, that acts as a means of support for floor and roof beams as well as other structural members.

**Corbelling**

A series of projections, each stepped out further than the one below it; most often found on walls and chimney stacks.

**Band**

Any flat horizontal member that projects slightly from the surface; often used to mark a division in a wall; also called band molding or band course.

**Course**

A horizontal row of stones, bricks, or other masonry units.

**Mortar**

A mixture of cement and lime with a fine aggregate and water; used for pointing and bonding bricks or stones.

**Quoins**

Large stones, or rectangular pieces of wood or brick, used to decorate and accentuate the corners of a building.

**Bond(ing)**

The repeating arrangement of bricks in various patterns.

Ornamentation (con't)

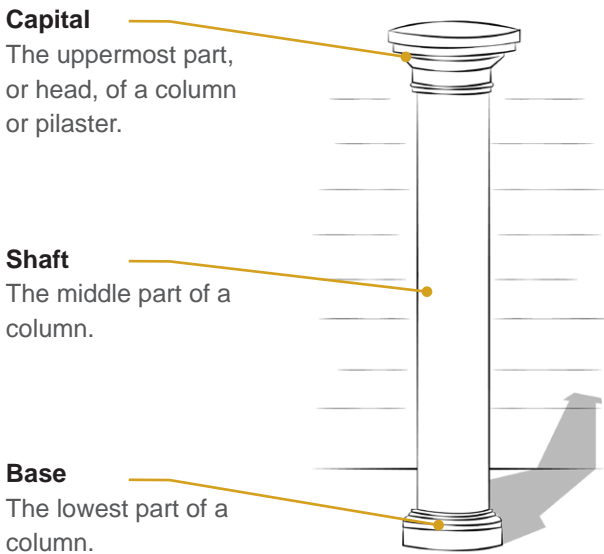
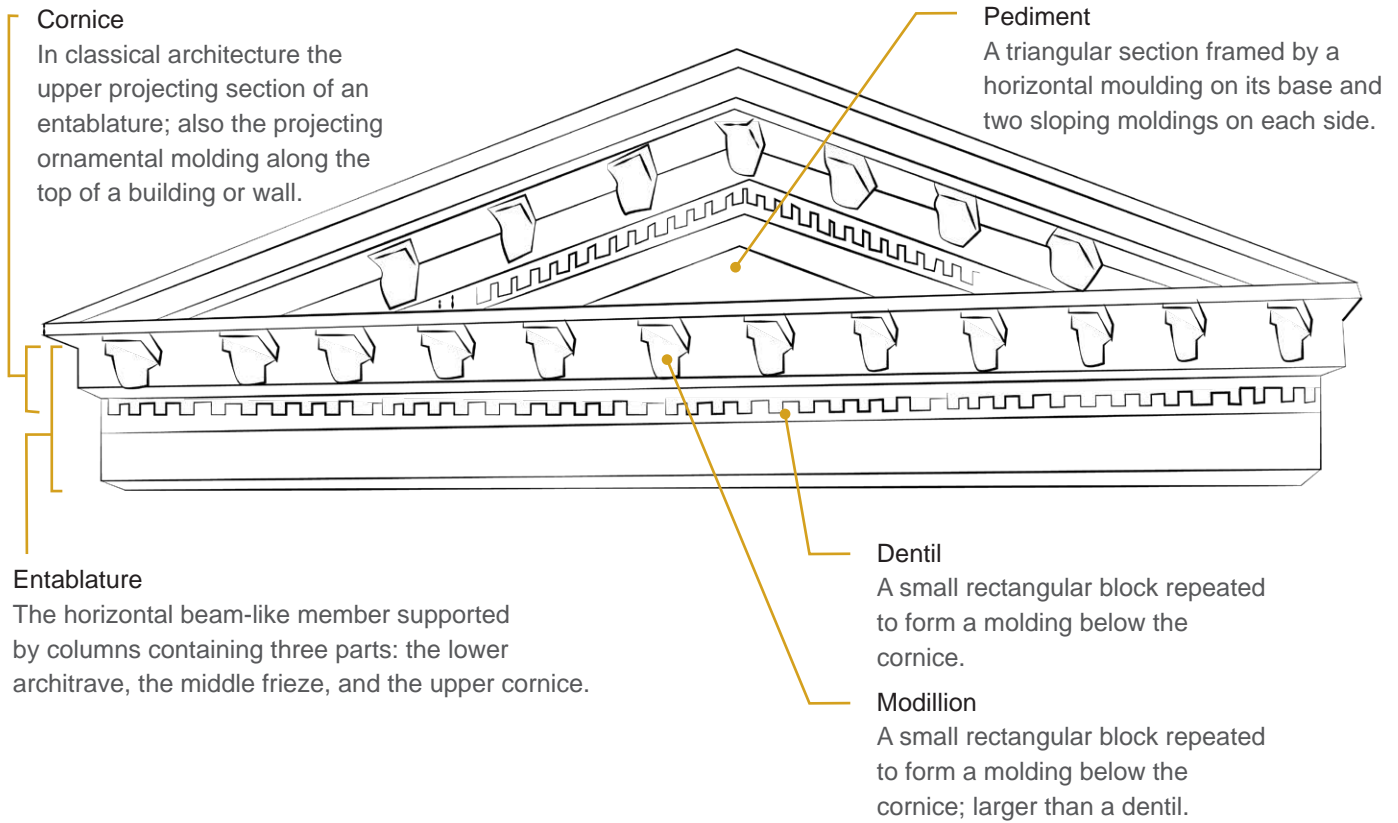

**Column**  
A round vertical support. In classical architecture the column has three parts: base, shaft, and capital.

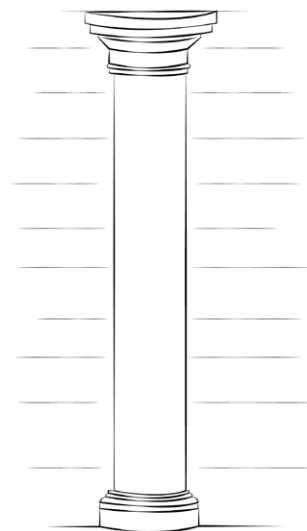

**Engaged column**  
A column that is in direct contact with a wall; at least half of the column projects beyond the surface of the wall to which it is engaged.

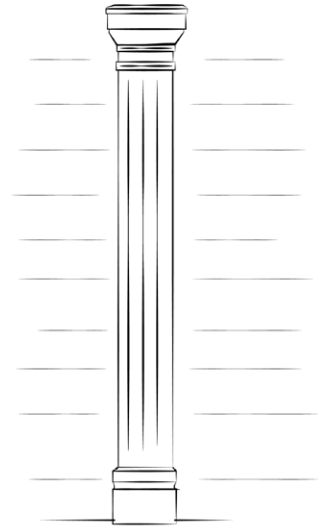

**Pilaster**  
A rectangular column or shallow pier attached to a wall.

## GLOSSARY

### Other terms

#### Arch

A curved, and sometimes pointed, structural member used to span an opening.

#### Areaway

A sunken area around a basement window or doorway, or mechanical air intake.

#### Awning

A lightweight projection that provides weather protection, identity or decoration and is wholly supported by the building to which it is attached; comprised of a frame structure over which a covering (often canvas) is attached.

#### Balcony

A railed projecting platform found above ground level on a building.

#### Baluster

One of a series of short pillars or other uprights that support a handrail or coping.

#### Balustrade

A series of balusters connected on top by a coping or a handrail and sometimes on the bottom by a bottom rail; used on staircases, balconies, and porches.

#### Bay

A space protruding from the exterior wall; typically contains a bay window.

#### Bead board

Wood paneling milled with a tongue on one side and a groove on the other, with one or more half-round beads on the surface; typically used on walls or ceilings.

#### Box chimney

A chimney enclosed by boards to create a box-like appearance.

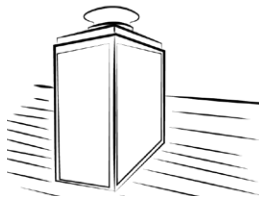

#### Caulking

A waterproof filler and sealant.

#### Consolidate

To stabilize a deteriorated material by adding another material (e.g., add epoxy resin to wood).

#### Coping

The protective uppermost course of a wall or parapet, coping commonly projects beyond the wall surface to throw off rain.

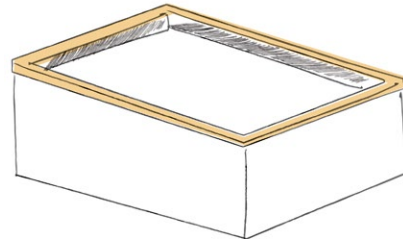

#### Crenellation

A parapet with alternating solid and void spaces, originally used for defense; also called a battlement.

#### Cupola

Typically a square, round, or octagonal structure constructed on the ridge of the roof and designed to allow ventilation or light into the space below.

#### Ell

An extension that is at right angles to the length of the building.

#### Efflorescence

A growth of salt crystals on a surface caused by the evaporation of water. It typically occurs when water is present on concrete, brick, or natural stone.

#### Fachwerk

Method of heavy timber framing combined with rubble masonry between the timbers, typically finished with stucco; typically associated with German settlers in Central Texas.

#### Flashing

Pieces of metal used around wall and roof junctions and angles as a means of preventing water infiltration.

#### Gazebo

An outdoor pavilion or summerhouse popular for lawns and gardens of rural houses in the Victorian era.

## GLOSSARY

### Other terms (con't)

#### **Gothic arch**

An arch that comes to a point at its apex, such as a lancet arch.

#### **Half-timbered**

Descriptive of 16th and 17th century houses built with heavy timber framing with the spaces filled in with plaster or masonry. This style of building was imitated in the 19th and early 20th centuries in the Tudor Revival style.

#### **Header**

The short side of a brick.

#### **Hood**

A protective and sometimes decorative cover over doors or windows.

#### **Keystone**

The central stone of an arch.

#### **Lattice**

Open work produced by interlacing of laths or other thin strips, often used as screening, especially in the base of a porch.

#### **Lime mortar**

A mortar made of lime (calcium oxide) and sand, typically used prior to the 1930s, that is more flexible than mortars made of Portland cement.

#### **Newel post**

The post supporting the handrail at the top and bottom of a stairway.

#### **Paneled door**

A door constructed with recessed rectangular panels surrounded by raised mouldings.

#### **Parapet**

A low wall or protective railing, usually used around the edge of a roof or around a balcony.

#### **Patio**

A usually paved and shaded area adjoining or enclosed by the walls of a house.

#### **Plaster**

A soft mixture of lime, gypsum, and/cement with sand and water for spreading on walls, ceilings, or other structures to form a smooth hard surface when dried.

#### **Porte cochere**

A roofed structure attached to a building and extending over a driveway, allowing vehicles to pass through.

#### **Portland cement**

A hydraulic cement binder for concrete and mortar; typically not used in construction prior to the 1930s.

#### **Rail**

A horizontal bar or beam that creates a barrier at the outer edge of a space such as a porch. Also a horizontal member of a door or window.

#### **Rake**

The slope of a gable, pediment, stair string, etc.

#### **Retaining wall**

A braced or freestanding wall that bears against an earthen backing.

#### **Repointing**

The process of removing deteriorated mortar from the joints of a masonry wall and replacing it with new mortar. Also known simply as "pointing" or—somewhat inaccurately—"tuck pointing." Properly done, repointing restores the visual and physical integrity of the masonry.

#### **Sandblasting**

An abrasive cleaning method where sand is used under pressure to physically abrade the surface to remove soils, discolorations, or coatings.

#### **Spalling**

Small fragments or chips of stone, brick, or stucco that may fall off in layers.

#### **Stretcher**

The long, rectangular side of a brick. A stretcher bond (also known as running bond) is the most common bond in modern times, as it is easy to lay, with little waste. Entirely comprised of stretcher bricks, set in rows (or "courses") that are offset by half a brick.

### **Substitute materials**

Building material used as a substitute for the original historic material. Typically, substitute materials are used to resemble the historic material and restore the visual appearance of historic resources.

### **Turret**

A small and somewhat slender tower; often located at the corner of a building.

### **Water table**

A projecting ledge or moulding near the base of the exterior wall designed to shed rainwater.

### **Wing wall**

A portion of the front façade extending past the side façade, often sloping down from the eaves to the ground at an angle.

### **Wrought iron**

An iron alloy with a very low carbon (less than 0.08%) content in contrast to cast iron (2.1% to 4%). Compared with cast iron, wrought iron is relatively soft, malleable, tough, fatigue-resistant, and readily worked by forging, bending, and drawing. Wrought-iron elements are generally simple in form and less uniform in appearance than cast-iron elements, and contain evidence of rolling or hand working.

## GLOSSARY

### *Index of terms*

Addition	107	Corbel	118
Alteration	107	Corbelling	118
Aluminum siding	113	Corner boards	118
Aluminum-sash window	116	Cornice	117, 119
Apron	115	Intermediate	117
Arch	120	Corrugated metal	113
Architectural fabric	107	Course	118
Areaway	120	Crenellation	120
Asbestos siding	113	Cross-gabled roof	111
Attic	109	Cupola	120
Awning	120	Curtain wall	113
Awning window	115	Deck	109
Balcony	120	Demolition	107
Baluster	120	Dentil	119
Balustrade	120	Dormer	111
Band	118	Eyebrow	112
Bargeboard	111	Double-hung window	115
Base	119	Downspout	112
Basement	109	Eaves	111
Battered foundation	110	Efflorescence	120
Bay	120	EIFS	114
Bay window	116	Elevation	109
Bead board	120	Ell	120
Board and batten	113	Engaged column	119
Bond(ing)	118	Entablature	119
Box chimney	120	Eyebrow dormer	112
Boxed eaves	112	Facade	109
Bracket	111	Fachwerk	120
Brick	113	Fanlight	116
Bulkhead	117	Fascia board	112
Canopy	117	Fenestration	109
Capital	119	Fiber cement siding	114
Casement window	115	Fixed sash	115
Cast iron	113	Flashing	120
Caulking	120	Flat roof	112
Cement, Portland	121	Flat roof with parapet	112
Character-defining feature	107	Foundation	109, 110
Clad-wood window	116	Front-gabled roof	111
Clapboard siding	113	Gable end	112
Clerestory	116	Gambrel roof	112
CMU (see concrete block)	113	Gazebo	120
Column	119	Gothic arch	120
Engaged	119	Gutter	112
Compatible	107	Half-timbered	121
Concrete	113	Header, brick	121
Concrete block	113	Header, opening	115
Concrete slab foundation	110	Hipped roof	111
Context	107	Historic building	107
Consolidate	120	Hood	121
Contributing property	107	Hopper window	115
Coping	120	In-kind repair	107



## GLOSSARY

Integrity	107	Scale	108
Intermediate cornice	117	Secondary building	108
Jalousie window	115	Shaft	119
Jamb	115	Shed roof	112
Keystone	121	Shingle	114
Lattice	121	Shiplap siding	114
Leaded glass window	116	Shutters	116
Lime mortar	121	Side light	116
Lintel	115	Side-gabled roof	111
Lite	115	Sill	115
Mansard roof	112	Single-hung window	115
Masonry foundation	110	Sliding window	115
Massing	107	Soffit	111
Modillion	119	Spalling	121
Molding	118	Standing-seam metal	114
Mortar	118	Steel-sash window	116
Lime	121	Storm window	116
Mullion	115	Stretcher	121
Muntin	115	Stucco	114
Newel post	121	Substitute materials	122
Noncontributing property	107	Surround	118
Outbuilding	108	Tongue and groove	114
Paneled door	121	Transom	116, 117
Parapet	121	Trim	118
Patio	121	Turret	122
Pediment	119	Vinyl siding	114
Period of significance	108	Vinyl-sash window	116
Permastone	114	Water table	122
Pier	117	Window	115-116
Pier and beam foundation	110	Wing wall	122
Pilaster	119	Wing-and-gable roof	111
Plaster	121	Wood-sash window	116
Porch	109	Wrought iron	122
Porte cochere	121		
Portland cement	121		
Preservation	108		
Principal building	108		
Pyramidal roof	111		
Quoins	118		
Rafter tails	111		
Rafters	111		
Rail	121		
Rake	121		
Reconstruction	108		
Rehabilitation	108		
Repointing	121		
Restoration	108		
Retaining wall	121		
Rhythm	108		
Roof	111-112		
Rusticated stone	114		
Sandblasting	121		
Sash	115		

# Image Credits

---

- p. i [People looking out over Austin], circa 1940s. William H. Foster, Jr. papers, 1942-1995 and undated, Austin Seminary Archives, Austin Presbyterian Theological Seminary, Austin, TX.
- p. 1 Construction of Doris Miller Auditorium in Rosewood Park, 1943. PICA 24209, Austin History Center, Austin Public Library.
- p. 4 Paramount Theatre, data unknown. Paramount Theatre.  
Addition in National Register district. Courtesy of a | parallel architecture
- p. 8 Austin Woman's Club at the North-Evans Chateau Bellevue. C01575, Austin History Center, Austin Public Library.
- p. 10 Contributing building with addition. Photograph by Karen McGraw.
- p. 11 Austin American-Statesman typesetters, 1949. ND-49-129N-01, Austin History Center, Austin Public Library.
- p. 21 Moonlight Tower, date unknown. PICA 18420, Austin History Center, Austin Public Library.
- p. 24 Ramp and chair lift. LPC Permit Guidebook, New York City Landmarks Preservation Commission.
- p. 27 Dorms at Huston-Tillotson, 1956. ND-56-A007-01, Austin History Center, Austin Public Library.
- p. 36 Aluminum siding. Genesis Pro Painting. Also appears on p. 113.
- p. 44 Sixth Street. Kenneth C. Zirkel, Wikimedia Commons, ShareAlike 3.0 Unported license.
- p. 46 Austin street scene, 1951. ND-51-292-02, Austin History Center, Austin Public Library.
- p. 50 Rear addition in National Register district. Courtesy of Cuppett Architects.
- p. 52 Rear addition in historic district (top left). Photograph by Karen McGraw.  
Addition to historic landmark (top right). Courtesy of Michael Hsu Office of Architecture.  
Rear addition in historic district (second from bottom). Courtesy of Thoughtbarn/Delineate Studio (TB/DS).  
Side addition to historic landmark (bottom). Photograph by Historic Preservation Office, design by Limbacher & Godfrey.
- p. 57 Joshua West Sr. Contractor, photograph, date unknown; (<https://texashistory.unt.edu/ark:/67531/metaph17424/>; accessed March 5, 2020), University of North Texas Libraries, The Portal to Texas History, <https://texashistory.unt.edu>; crediting Jacob Fontaine Religious Museum.
- p. 60 Proposed duplexes. Courtesy of Alamo Architects.
- p. 64 New house in National Register district (top). Photograph by Historic Preservation Office, design by Davey McEathron Architecture.  
New house in historic district (middle). Courtesy of Ahs design group.  
New house in Cedar Rapids historic district (bottom), photographed by Liz Martin. Source: *The Gazette*.
- p. 66 New house in National Register district. Courtesy of Michael Hsu Office of Architecture.
- p. 69 Austin Machine & Supply Co., 1957. ND-57-363-03, Austin History Center, Austin Public Library.
- p. 74 Pittman Hotel, Dallas, photographed by Leonid Furmansky (top). Courtesy of Perkins&Will.

- p. 74 W.S. Hills Building, El Paso (middle). Courtesy of In\*Situ Architecture.
- p. 76 Rooftop patios. Courtesy of the Texas Historical Commission.
- p. 77 Rail crew on E. 6th Street, ca. 1890-99. PICA 36121, Austin History Center, Austin Public Library.
- p. 82 AC Hotel Fort Worth. Courtesy of Downtown Fort Worth, Inc.
- p. 83 Wesley Chapel M.E. Church, date unknown (<https://texashistory.unt.edu/ark:/67531/metaph17388/>; accessed September 16, 2020), University of North Texas Libraries, The Portal to Texas History, <https://texashistory.unt.edu>; crediting Jacob Fontaine Religious Museum.
- p. 86 Palm Elementary, 192u. C03746, Austin History Center, Austin Public Library.
- p. 87 Campfire float at Fiesta del Barrio. PICA 29995, Austin History Center, Austin Public Library.
- p. 94 Texas State Capitol, view up Congress Avenue at night, date unknown. Courtesy of Texas Historical Commission ([thc.texas.gov](http://thc.texas.gov)).
- p. 95 Airplanes flying over Austin, 1940. APSL-AR-2000-024-576. Austin History Center, Austin Public Library.
- p. 99 Boys making model airplanes at the Pan American Recreation Center, 1946. PICA 26151, Austin History Center, Austin Public Library.
- p. 105 Children playing at Rosewood Park, ca. 1959-69. PICA 24201, Austin History Center, Austin Public Library.

All other images were produced for this document and/or are owned by the City of Austin.





# HOUSING & PLANNING